

TOP SELECTION GARDEN 2020 - MODERN RANGE

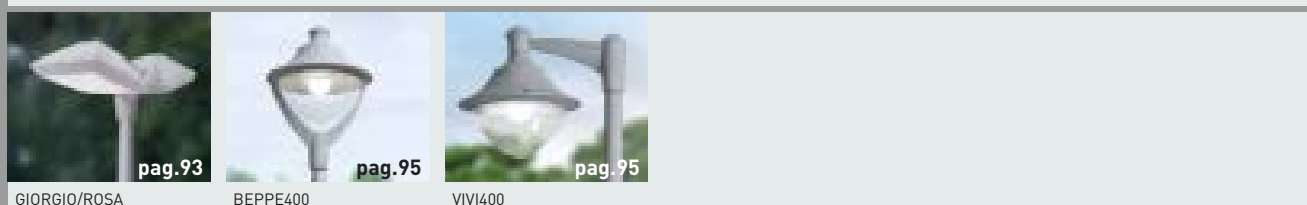

NEW PRODUCTS

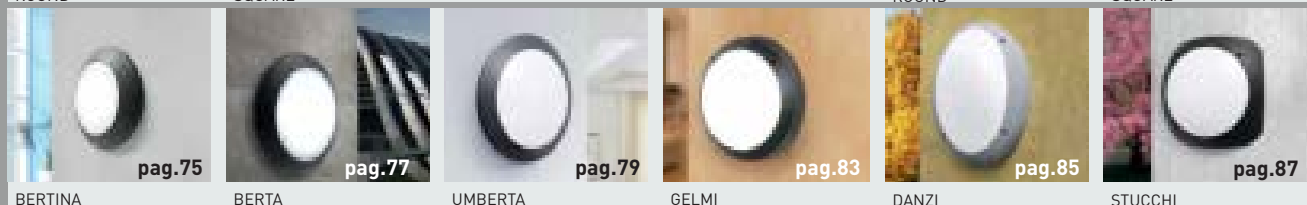
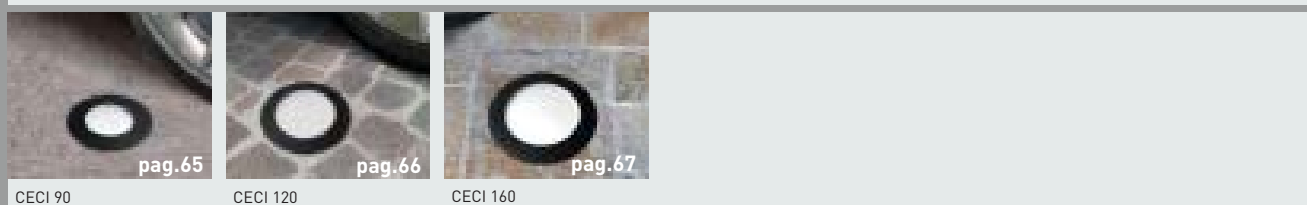
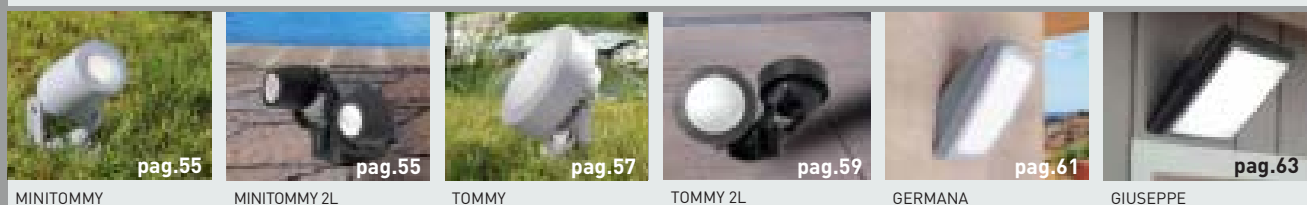

BOLLARD

UP&DOWN

FLOODLIGHT

IN-GROUND

BRICKLIGHT

BULKHEAD

POLE

SOLAR RANGE



SOLAR MODULE



3 WORKING MODE



SUMMER MODE 1 flash	WINTER MODE 2 flash	SENSOR MODE 3 flash	STAND BY MODE
 15% 42Lm 100% 280Lm for 25 sec.	 7% 20Lm 100% 280Lm for 25 sec.	 OFF 100% 280Lm for 25 sec.	OFF
AUTONOMY 25h (at fully charged battery)	AUTONOMY 46h (at fully charged battery)	423 SENSOR DETECTIONS (at fully charged battery)	NO WORKING TO PRESERVE THE BATTERY
CHARGING TIME 6h at 60.000 Lux (full sunny day)			

REPLACEABLE BATTERY

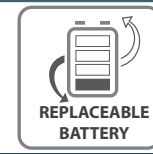

- LiFePO4 IFR 26650 3,3Ah-3,2V
- No risk of explosion
- Working temperature -10° to +60°C
- Longer Lifetime



MOTION SENSOR



- PIR Sensor control
- Detection angle 120°
- Fields of detection up to 5mt
- Active for 25 sec.



CCT SETTABLE LED



- 3000K/4000K/6500K

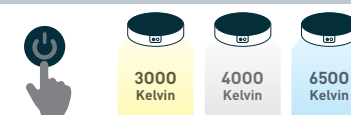

CRI >80
SDCM <6

SOLAR PANEL

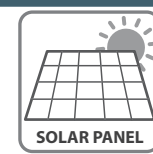

- 5V/2W
- Monocrystalline PET type
- Antishock material



4 NEWS
28 BOLLARD
46 UP&DOWN
54 FLOODLIGHT
64 IN-GROUND
68 BRICKLIGHT
74 BULKHEAD
92 POST
96 LAMPS

FELICE

SOLAR LED



FE1.575.S1KOP2



REFLECTOR - OPTIONAL COLOURS		
CLEAR	BLUE	GREEN
code: HX.SOL.RFL	code: HU.SOL.RFL	code: HN.SOL.RFL



SOLAR LED

FELICE

FELICE SOLAR				
SOLAR MODULE	BATTERY LiFePO4	SOLAR PANEL	LUMINOUS FLUX	CCT SETTABLE
	3,3Ah 3,2V	5V/2W	max 280Lm	6500K/4000K/3000K



AVAILABLE COLORS			
RESIN BODY (MOULDED COLOURS)			REFLECTOR (STANDARD VERSION)
BLACK (A)	GREY (L)	WHITE (W)	OPAL (.OP2)

FELICE 800

FE1.575.S1KOP2
OPAL REFLECTOR

NEW

WORKING MODE 3 SENSOR CCT SET

Master box: 4pcs

FELICE 400

FE1.574.S1KOP2
OPAL REFLECTOR

NEW

WORKING MODE 3 SENSOR CCT SET

Master box: 12pcs

FELICE 200

FE1.573.S1KOP2
OPAL REFLECTOR

NEW

WORKING MODE 3 SENSOR CCT SET

Master box: 18pcs

FELICE 200 SPIKE

FE1.572.S1KOP2
OPAL REFLECTOR

NEW

WORKING MODE 3 SENSOR CCT SET

Master box: 18pcs

4 NEWS
28 BOLLARD
46 UP&DOWN
54 FLOODLIGHT
64 IN-GROUND
68 BRICKLIGHT
74 BULKHEAD
92 POST
96 LAMPS

FIORINA

SOLAR LED



FI1.542.S1K



SOLAR LED

FIORINA/FORTUNATO

FELICE SOLAR				
SOLAR MODULE	BATTERY LiFePO4	SOLAR PANEL	LUMINOUS FLUX	CCT SETTABLE
	3,3Ah 3,2V	5V/2W	max 280Lm	6500K/4000K/3000K

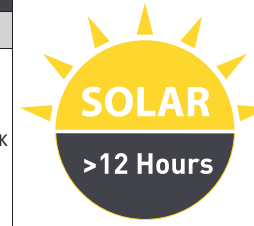

AVAILABLE COLORS		
RESIN BODY (MOULDED COLOURS)		
BLACK (A)	GREY (L)	WHITE (W)

FIORINA



NEW

FI1.542.S1K

SPIKE INSTALLATION

GROUND INSTALLATION

DUAL USE

Master box: 6pcs

FORTUNATO



NEW

FO1.000.S1K

Master box: 12pcs

4 NEWS
28 BOLLARD
46 UP&DOWN
54 FLOODLIGHT
64 IN-GROUND
68 BRICKLIGHT
74 BULKHEAD
92 POST
96 LAMPS

STEVEN

BOLLARD RANGE



MADE IN ITALY



ST1.531.Z1R



BOLLARD

STEVEN

STEVEN LED VERSIONS				
LAMP	POWER	LUMINOUS FLUX	VOLTAGE RANGE	COLOUR TEMPERATURE
G9 LED	1,7W	170Lm	100-240V 50/60 Hz	4000K
				3000K



AVAILABLE COLORS			
COVER (MOULDED COLOURS)			DIFFUSER
BLACK (A)	GREY (L)	WHITE (W)	FROSTED (X) BLUE (U) GREEN (N) ORANGE (R)

STEVEN



1,7W	4000K	ST1.531.Z1L
	3000K	ST1.531.Z1R

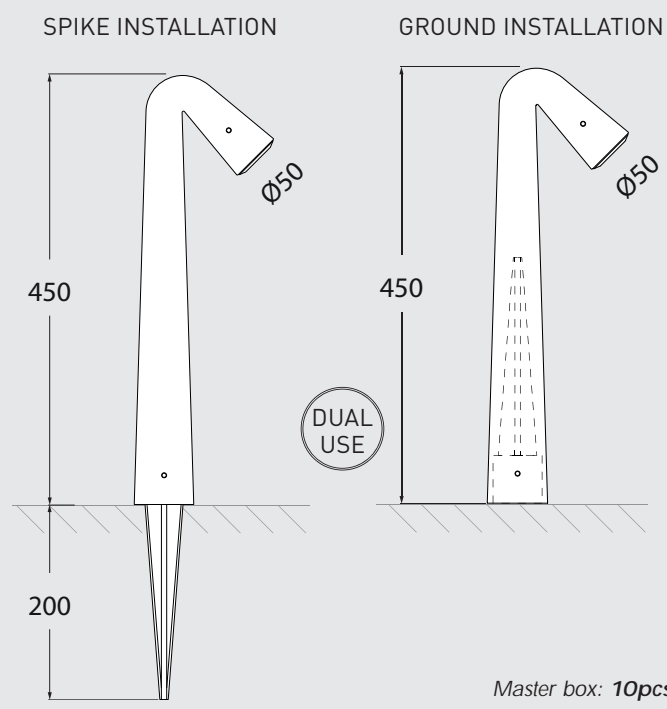

4 NEWS
28 BOLLARD
46 UP&DOWN
54 FLOODLIGHT
64 IN-GROUND
68 BRICKLIGHT
74 BULKHEAD
92 POST
96 LAMPS

MAMETE

UP & DOWN



WALL INSTALLATION

2A3.000.Z1L

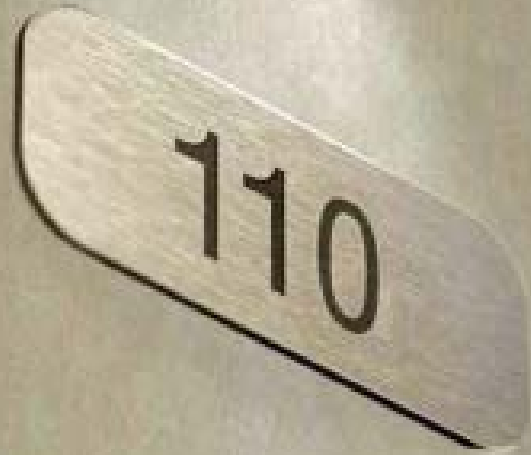

1A3.000.Z1L

GROUND INSTALLATION

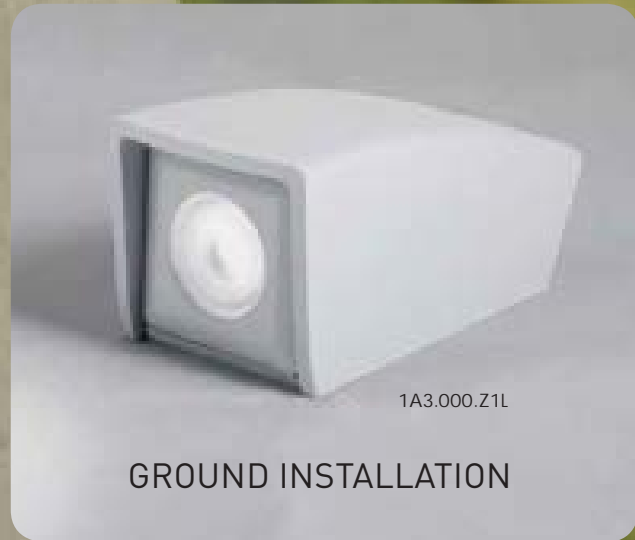

UP & DOWN

MAMETE

MAMETE LED VERSIONS				
LAMP	POWER	LUMINOUS FLUX	VOLTAGE RANGE	COLOUR TEMPERATURE
	1,7W	170Lm	100-240V 50/60 Hz	4000K 3000K

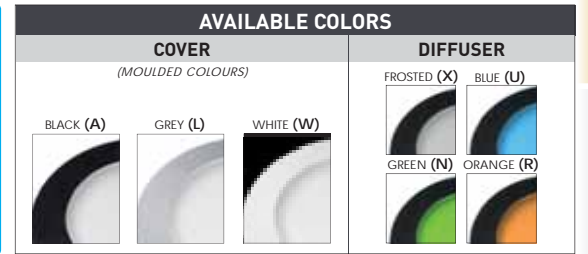
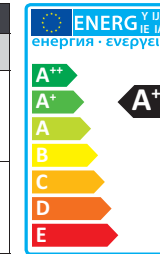

MAMETE SQUARE



LED G9 LAMP INCLUDED

1,7W	4000K	1A3.000.Z1L
	3000K	1A3.000.Z1R

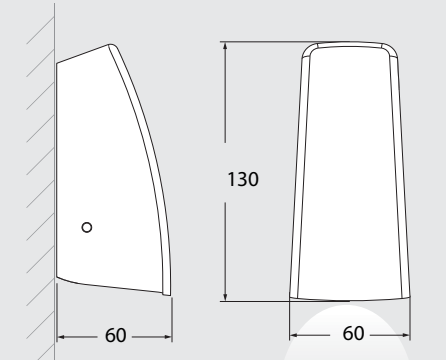
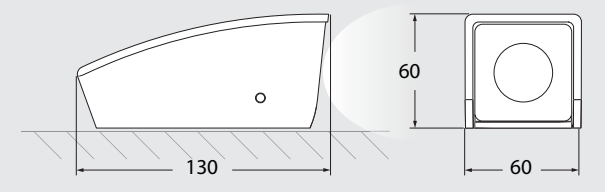

Master box: 50pcs

MAMETE ROUND



LED G9 LAMP INCLUDED

1,7W	4000K	2A3.000.Z1L
	3000K	2A3.000.Z1R

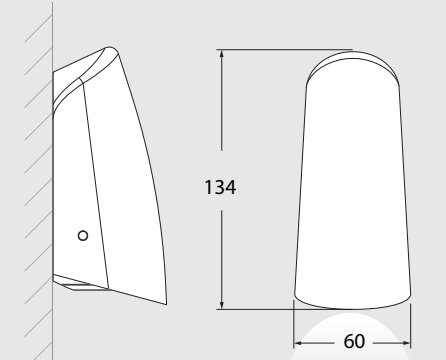
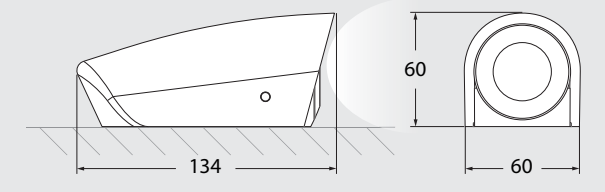

Master box: 50pcs

4 NEWS
28 BOLLARD
46 UP&DOWN
54 FLOODLIGHT
64 IN-GROUND
68 BRICKLIGHT
74 BULKHEAD
92 POST
96 LAMPS

ALDO

IN-GROUND / RECESSED

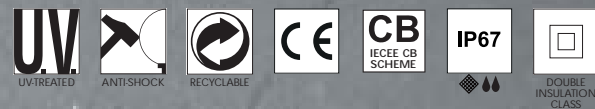

MADE IN ITALY



1L1.000.Z1L



IN-GROUND/RECESSED

ALDO

ALDO LED VERSIONS				
LAMP	POWER	LUMINOUS FLUX	VOLTAGE RANGE	COLOUR TEMPERATURE
	1,7W	170lm	100-240V 50/60 Hz	4000K 3000K



ALDO

IN GROUND		1,7W 4000K 3000K	1L0.000.Z1L 1L0.000.Z1R	LED G9 LAMP INCLUDED	RECESSED
-----------	--	------------------------	----------------------------	----------------------	----------

NEW Master box: 75pcs

ALDO 1L

IN GROUND		1,7W 4000K 3000K	1L1.000.Z1L 1L1.000.Z1R	LED G9 LAMP INCLUDED	RECESSED
-----------	--	------------------------	----------------------------	----------------------	----------

NEW Master box: 75pcs

ALDO 2L

IN GROUND		1,7W 4000K 3000K	1L2.000.Z1L 1L2.000.Z1R	LED G9 LAMP INCLUDED	RECESSED
-----------	--	------------------------	----------------------------	----------------------	----------

NEW Master box: 75pcs

ALDO SQUARE

IN GROUND		1,7W 4000K 3000K	1L4.000.Z1L 1L4.000.Z1R	LED G9 LAMP INCLUDED	RECESSED
-----------	--	------------------------	----------------------------	----------------------	----------

NEW Master box: 75pcs

4 NEWS
28 BOLLARD
46 UP&DOWN
54 FLOODLIGHT
64 IN-GROUND
68 BRICKLIGHT
74 BULKHEAD
92 POST
96 LAMPS

TERESA

DOWNLIGHT / DECKLIGHT



2L0.000.Z1L

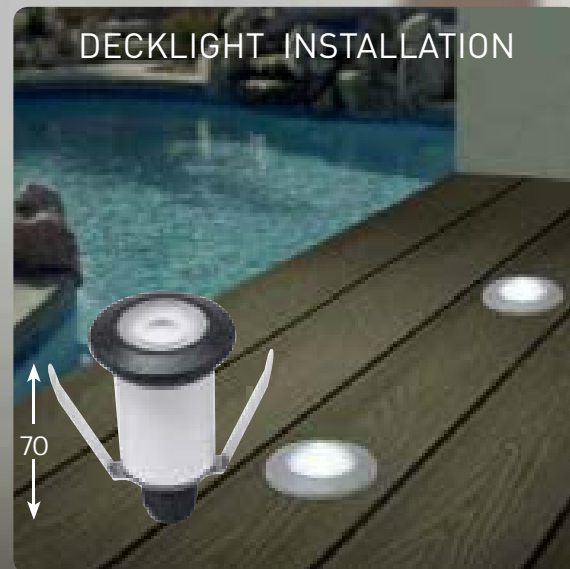

DOWNLIGHT/DECKLIGHT

TERESA

TERESA LED VERSIONS				
LAMP	POWER	LUMINOUS FLUX	VOLTAGE RANGE	COLOUR TEMPERATURE
	1,7W	170Lm	100-240V 50/60 Hz	4000K
				3000K

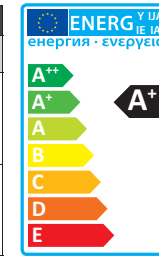

TERESA

1,7W	4000K	2L0.000.Z1L
	3000K	2L0.000.Z1R

NEW

LED G9 LAMP INCLUDED

Master box: 75pcs

TERESA SQUARE

1,7W	4000K	2L4.000.Z1L
	3000K	2L4.000.Z1R

NEW

LED G9 LAMP INCLUDED

Master box: 75pcs

TERESA 1L

1,7W	4000K	2L1.000.Z1L
	3000K	2L1.000.Z1R

NEW

LED G9 LAMP INCLUDED

Master box: 75pcs

TERESA 2L

1,7W	4000K	2L2.000.Z2L
	3000K	2L2.000.Z1R

NEW

LED G9 LAMP INCLUDED

Master box: 75pcs

NEWS 4
BOLLARD 28
UP&DOWN 46
FLOODLIGHT 54
IN-GROUND 64
BRICKLIGHT 68
BULKHEAD 74
POST 92
LAMPS 96

LIVIA RANGE

DOWNLIGHT



MADE IN ITALY



1A9.000.Z1L

AVAILABLE COLORS			
RESIN BODY <small>(MOULDED COLOURS)</small>			DIFFUSER
BLACK (A)	GREY (L)	WHITE (W)	FROSTED (X)



DOWNLIGHT

LIVIA RANGE

LIVIA 60 LED VERSIONS				
LAMP	POWER	LUMINOUS FLUX	VOLTAGE RANGE	COLOUR TEMPERATURE
	1,7W	170Lm	100-240V 50/60 Hz	4000K
				3000K

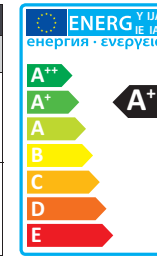

LIVIA 90 LED VERSIONS				
LAMP	POWER	LUMINOUS FLUX	VOLTAGE RANGE	CCT SETTABLE
	3,5W	350Lm	100-240V 50/60 Hz	4000K/2700K =
	6W	600Lm	100-240V 50/60 Hz	4000K/2700K =

LIVIA 60

LED G9 LAMP INCLUDED	POWER	TEMPERATURE	MODEL
	1,7W	4000K	1A9.000.Z1L
	3000K		1A9.000.Z1R

NEW

Master box: 75pcs

LIVIA 90

LED GU10 LAMP INCLUDED	POWER	MODEL
	3,5W	2A9.000.U1K
	6W	2A9.000.L1K

NEW

NEW VERSION CCT SETTABLE LAMP

Master box: 30pcs

4 NEWS
28 BOLLARD
46 UP&DOWN
54 FLOODLIGHT
64 IN-GROUND
68 BRICKLIGHT
74 BULKHEAD
92 POST
96 LAMPS

LIVIA RANGE

DOWNLIGHT



MADE IN ITALY

3A9.000.G1K

AVAILABLE COLORS			
RESIN BODY <small>(MOULDED COLOURS)</small>			DIFFUSER
BLACK (A)	GREY (L)	WHITE (W)	FROSTED (X)



DOWNLIGHT

LIVIA RANGE

LIVIA 160 LED VERSIONS NEW					
LAMP	POWER	LUMINOUS FLUX	VOLTAGE RANGE	CCT SETTABLE	
	3W	350Lm	100-240V 50/60 Hz	6500K/4000K/3000K	= 40W INCANDESCENT
	7W	800Lm	100-240V 50/60 Hz	6500K/4000K/3000K	= 75W INCANDESCENT
	10W	1200Lm	100-240V 50/60 Hz	6500K/4000K/3000K	= 100W INCANDESCENT

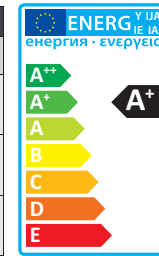

LIVIA 180 LED VERSIONS					
LAMP	POWER	LUMINOUS FLUX	VOLTAGE RANGE	COLOUR TEMPERATURE	
	15W	1800Lm	100-240V 50/60 Hz	4000K 3000K	= 50W HQI-SON
	30W	3500Lm	100-240V 50/60 Hz	4000K 3000K	= 70W HQI-SON

LIVIA 160

LED GX53 LAMP INCLUDED	3W	3A9.000.G1K
CCT SET	7W	3A9.000.C1K
	10W	3A9.000.D1K

NEW

NEW VERSION CCT SETTABLE LAMP

Master box: 18pcs

LIVIA 180

LED E27 HIGH POWER LAMP INCLUDED	15W	4000K	4A9.000.R1L
		3000K	4A9.000.R1R
	30W	4000K	4A9.000.Q1L
		3000K	4A9.000.Q1R

NEW

Master box: 12pcs

4 NEWS
28 BOLLARD
46 UP&DOWN
54 FLOODLIGHT
64 IN-GROUND
68 BRICKLIGHT
74 BULKHEAD
92 POST
96 LAMPS

NINA RANGE

RECESSED



MADE IN ITALY



6C1.000.J1K

CCT SETTABLE NEW

2700 K 4000 K 6500 K

SDCM <6



RECESSED

NINA RANGE

NINA LED VERSIONS NEW

LAMP	POWER	LUMINOUS FLUX	VOLTAGE RANGE	CCT SETTABLE
R7s LED	3,2hW	400Lm	100-240V 50/60 Hz	6500K/4000K/2700K
R7s LED	7,5W	850Lm	100-240V 50/60 Hz	6500K/4000K/2700K
R7s LED	10,5W	1100Lm	100-240V 50/60 Hz	6500K/4000K/2700K

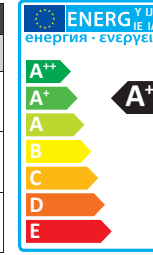

AVAILABLE COLORS

RESIN BODY (MOULDED COLOURS)			DIFFUSER
BLACK (A)	GREY (L)	WHITE (W)	OPAL (Y)

NINA 150

CCT SET	LED R7s LAMP INCLUDED	3,2W	6C1.000.J1K
----------------	------------------------------	------	-------------

NEW VERSION CCT SETTABLE LAMP

NEW

400 lm

Master box: 50pcs

NINA 190

CCT SET	LED R7s LAMP INCLUDED	7,5W	7C1.000.K1K
----------------	------------------------------	------	-------------

NEW VERSION CCT SETTABLE LAMP

NEW

850 lm

Master box: 50pcs

NINA 270

CCT SET	LED R7s LAMP INCLUDED	10,5W	8C1.000.P1K
----------------	------------------------------	-------	-------------

NEW VERSION CCT SETTABLE LAMP

NEW

1100 lm

Master box: 30pcs

4 NEWS
28 BOLLARD
46 UP&DOWN
54 FLOODLIGHT
64 IN-GROUND
68 BRICKLIGHT
74 BULKHEAD
92 POST
96 LAMPS

ABRAM RANGE

UP&DOWN



MADE IN ITALY



AB1.000.J1K

CCT SETTABLE NEW

2700 K 4000 K 6500 K

SDCM <6



UP&DOWN

ABRAM RANGE

ADAM LED VERSIONS				CCT SETTABLE
LAMP	POWER	LUMINOUS FLUX	VOLTAGE RANGE	
R7s LED	3,2W	400Lm	100-240V 50/60 Hz	6500K/4000K/2700K
R7s LED	7,5W	850Lm	100-240V 50/60 Hz	6500K/4000K/2700K
R7s LED	10,5W	1100Lm	100-240V 50/60 Hz	6500K/4000K/2700K

NEW

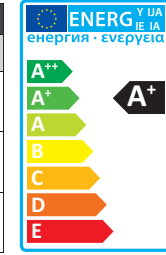

AVAILABLE COLORS

RESIN BODY (MOULDED COLOURS)

BLACK (A) GREY (L) WHITE (W)

DIFFUSER

CLEAR (X)

ABRAM 150

CCT SET **LED R7s LAMP INCLUDED** 3,2W AB1.000.J1K

NEW VERSION CCT SETTABLE LAMP

400 Lm

Master box: 30pcs

ABRAM 190

CCT SET **LED R7s LAMP INCLUDED** 7,5W AB2.000.K1K

NEW VERSION CCT SETTABLE LAMP

850 Lm

Master box: 30pcs

ABRAM 270

CCT SET **LED R7s LAMP INCLUDED** 10,5W AB3.000.P1K

NEW VERSION CCT SETTABLE LAMP

1100 Lm

Master box: 14pcs

MADE IN ITALY

4 NEWS
28 BOLLARD
46 UP&DOWN
54 FLOODLIGHT
64 IN-GROUND
68 BRICKLIGHT
74 BULKHEAD
92 POST
96 LAMPS

LORENZA RANGE

SURFACE



MADE IN ITALY



AS1.000.J1K

CCT SETTABLE NEW

2700 K 4000 K 6500 K

SDCM <6



SURFACE

LORENZA RANGE

LORENZALED VERSIONS NEW

LAMP	POWER	LUMINOUS FLUX	VOLTAGE RANGE	CCT SETTABLE
R7s LED	3,2W	400Lm	100-240V 50/60 Hz	6500K/4000K/2700K
R7s LED	7,5W	850Lm	100-240V 50/60 Hz	6500K/4000K/2700K
R7s LED	10,5W	1100Lm	100-240V 50/60 Hz	6500K/4000K/2700K

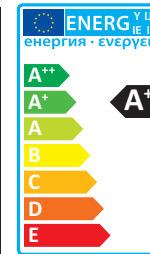

AVAILABLE COLORS

RESIN BODY
(MOULDED COLOURS)

BLACK (A) GREY (L) WHITE (W)

DIFFUSER

CLEAR (X)

LORENZA 150

CCT SET **LED R7s LAMP INCLUDED** 3,2W AS1.000.J1K

NEW VERSION CCT SETTABLE LAMP

NEW 400 lm

150 150 45

Master box: 24pcs

LORENZA 190

CCT SET **LED R7s LAMP INCLUDED** 7,5W AS2.000.K1K

NEW VERSION CCT SETTABLE LAMP

NEW 850 lm

150 190 45

Master box: 24pcs

LORENZA 270

CCT SET **LED R7s LAMP INCLUDED** 10,5W AS3.000.P1K

NEW VERSION CCT SETTABLE LAMP

NEW 1100 lm

150 260 45

Master box: 14pcs

MADE IN ITALY

NEWS 4
BOLLARD 28
UP&DOWN 46
FLOODLIGHT 54
IN-GROUND 64
BRICKLIGHT 68
BULKHEAD 74
POST 92
LAMPS 96

CARLO / CARLO DECO

BOLLARD RANGE



DR1.575



DR3.570



DR3.574

CCT SETTABLE **NEW**

2700 K 4000 K

SDCM <6



BOLLARD CARLO / CARLO DECO

CARLO LED VERSIONS NEW					
LAMP	POWER	LUMINOUS FLUX	VOLTAGE RANGE	CCT SETTABLE	
GU10 LED	3,5W	350Lm	100-240V 50/60 Hz	4000K/2700K	= 50W HALOGEN
GU10 LED	6W	600Lm	100-240V 50/60 Hz	4000K/2700K	= 100W HALOGEN

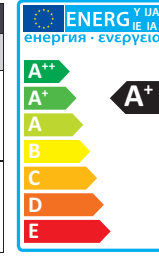

AVAILABLE COLORS			
RESIN BODY (MOULDED COLOURS)			DIFFUSER
BLACK (A)	GREY (L)	WHITE (W)	CLEAR (X)

CARLO 800

LED GU10 LAMP INCLUDED

CCT SET

CARLO 800 DECO

LED GU10 LAMP INCLUDED

CCT SET

3,5W	DR1.575.U1K
6W NEW	DR1.575.L1K
3,5W	DR3.575.U1K
6W NEW	DR3.575.L1K

NEW VERSION CCT SETTABLE LAMP

Master box: 6pcs

CARLO 400

LED GU10 LAMP INCLUDED

CCT SET

CARLO 400 DECO

LED GU10 LAMP INCLUDED

CCT SET

3,5W	DR1.574.U1K
6W NEW	DR1.574.L1K
3,5W	DR3.574.U1K
6W NEW	DR3.574.L1K

NEW VERSION CCT SETTABLE LAMP

Master box: 12pcs

4 NEWS
28 BOLLARD
46 UP&DOWN
54 FLOODLIGHT
64 IN-GROUND
68 BRICKLIGHT
74 BULKHEAD
92 POST
96 LAMPS

CARLO LED VERSIONS				
LAMP	POWER	LUMINOUS FLUX	VOLTAGE RANGE	CCT SETTABLE
	3,5W	350Lm	100-240V 50/60 Hz	4000K/2700K =
	6W	600Lm	100-240V 50/60 Hz	4000K/2700K =

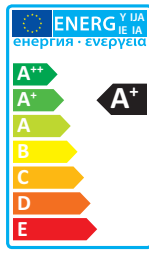

CARLO LED VERSIONS				
LAMP	POWER	LUMINOUS FLUX	VOLTAGE RANGE	CCT SETTABLE
	3,5W	350Lm	100-240V 50/60 Hz	4000K/2700K =
	6W	600Lm	100-240V 50/60 Hz	4000K/2700K =

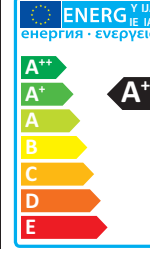

AVAILABLE COLORS			
RESIN BODY (MOULDED COLOURS)			DIFFUSER
BLACK (A)	GREY (L)	WHITE (W)	CLEAR (X)

CARLO 250

LED GU10 LAMP INCLUDED
CCT SET

- 3,5W DR1.573.U1K
- 6W **NEW** DR1.573.L1K
- 3,5W DR3.573.U1K
- 6W **NEW** DR3.573.L1K

NEW VERSION CCT SETTABLE LAMP

Master box: 20pcs

CARLO 250 DECO

LED GU10 LAMP INCLUDED
CCT SET

Master box: 20pcs

CARLO SPIKE

LED GU10 LAMP INCLUDED
CCT SET

- 3,5W DR1.572.U1K
- 6W **NEW** DR1.572.L1K
- 3,5W DR3.572.U1K
- 6W **NEW** DR3.572.L1K

NEW VERSION CCT SETTABLE LAMP

Master box: 20pcs

CARLO SPIKE DECO

LED GU10 LAMP INCLUDED
CCT SET

Master box: 20pcs

CARLO WALL

LED GU10 LAMP INCLUDED
CCT SET

- 3,5W DR1.570.U1K
- 6W **NEW** DR1.570.L1K
- 3,5W DR3.570.U1K
- 6W **NEW** DR3.570.L1K

NEW VERSION CCT SETTABLE LAMP

Master box: 20pcs

CARLO WALL DECO

LED GU10 LAMP INCLUDED
CCT SET

Master box: 20pcs

CARLO-FS

LED GU10 LAMP INCLUDED
CCT SET

- 3,5W DR1.571.U1K
- 6W **NEW** DR1.571.L1K
- 3,5W DR3.571.U1K
- 6W **NEW** DR3.571.L1K

NEW VERSION CCT SETTABLE LAMP

Master box: 20pcs

CARLO-FS DECO

LED GU10 LAMP INCLUDED
CCT SET

Master box: 20pcs

4 NEWS
 28 BOLLARD
 46 UP&DOWN
 54 FLOODLIGHT
 64 IN-GROUND
 68 BRICKLIGHT
 74 BULKHEAD
 92 POST
 96 LAMPS

AMELIA

BOLLARD RANGE

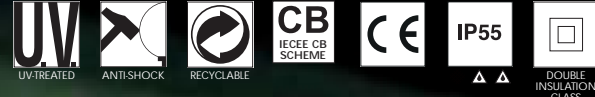

MADE IN ITALY



DR2.575



BOLLARD

AMELIA

AMELIA LED VERSIONS					
LAMP	POWER	LUMINOUS FLUX	VOLTAGE RANGE	COLOUR TEMPERATURE	
FILAMENT LED E27	6W	800Lm	100-240V 50/60 Hz	4000K 2700K	60W INCANDESCENT
	8W	1000Lm	100-240V 50/60 Hz	4000K 2700K	75W INCANDESCENT
FILAMENT LED E27 (A70)	12W	1500Lm	100-240V 50/60 Hz	4000K 2700K	100W INCANDESCENT

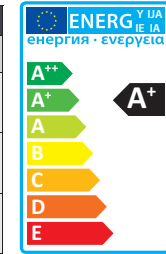

AVAILABLE COLORS			
RESIN BODY (MOULDED COLOURS)			DIFFUSER
BLACK (A)	GREY (L)	WHITE (W)	OPAL (Y)

AMELIA 800

LED FILAMENT LAMP INCLUDED	POWER	COLOUR TEMPERATURE	MODEL
LED FILAMENT LAMP INCLUDED	6W	4000K 2700K	DR2.575.F1L DR2.575.F1R
	8W	4000K 2700K	DR2.575.M1L DR2.575.M1R
LED FILAMENT LAMP INCLUDED	12W	4000K 2700K	DR2.575.N1L DR2.575.N1R

Master box: 6pcs

AMELIA 400

LED FILAMENT LAMP INCLUDED	POWER	COLOUR TEMPERATURE	MODEL
LED FILAMENT LAMP INCLUDED	6W	4000K 2700K	DR2.574.F1L DR2.574.F1R
	8W	4000K 2700K	DR2.574.M1L DR2.574.M1R
LED FILAMENT LAMP INCLUDED	12W	4000K 2700K	DR2.574.N1L DR2.574.N1R

Master box: 12pcs

AMELIA 250

LED FILAMENT LAMP INCLUDED	POWER	COLOUR TEMPERATURE	MODEL
LED FILAMENT LAMP INCLUDED	6W	4000K 2700K	DR2.573.F1L DR2.573.F1R
	8W	4000K 2700K	DR2.573.M1L DR2.573.M1R
LED FILAMENT LAMP INCLUDED	12W	4000K 2700K	DR2.573.N1L DR2.573.N1R

Master box: 20pcs

AMELIA SPIKE

LED FILAMENT LAMP INCLUDED	POWER	COLOUR TEMPERATURE	MODEL
LED FILAMENT LAMP INCLUDED	6W	4000K 2700K	DR2.572.F1L DR2.572.F1R
	8W	4000K 2700K	DR2.572.M1L DR2.572.M1R
LED FILAMENT LAMP INCLUDED	12W	4000K 2700K	DR2.572.N1L DR2.572.N1R

Master box: 20pcs

MADE IN ITALY

4 NEWS
28 BOLLARD
46 UP&DOWN
54 FLOODLIGHT
64 IN-GROUND
68 BRICKLIGHT
74 BULKHEAD
92 POST
96 LAMPS

AMELIA

WALL LAMP RANGE



MADE IN ITALY



DR2.570



BOLLARD

AMELIA

AMELIA LED VERSIONS					
LAMP	POWER	LUMINOUS FLUX	VOLTAGE RANGE	COLOUR TEMPERATURE	
 FILAMENT LED E27	6W	800Lm	100-240V 50/60 Hz	4000K 2700K	60W INCANDESCENT
	8W	1000Lm	100-240V 50/60 Hz	4000K 2700K	75W INCANDESCENT
 FILAMENT LED E27 (A70)	12W	1500Lm	100-240V 50/60 Hz	4000K 2700K	100W INCANDESCENT

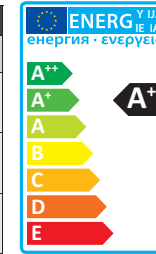

AVAILABLE COLORS			
RESIN BODY (MOULDED COLOURS)			DIFFUSER
BLACK (A)	GREY (L)	WHITE (W)	OPAL (Y)

AMELIA WALL



LED FILAMENT LAMP INCLUDED	POWER	COLOUR TEMPERATURE	MODEL
 LED FILAMENT LAMP INCLUDED	6W	4000K 2700K	DR2.570.F1L DR2.570.F1R
	8W	4000K 2700K	DR2.570.M1L DR2.570.M1R
 LED FILAMENT LAMP INCLUDED	12W	4000K 2700K	DR2.570.N1L DR2.570.N1R

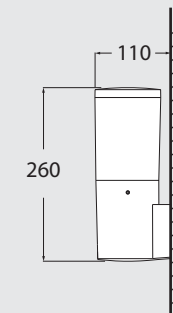

Master box: 20pcs

AMELIA-FS



LED FILAMENT LAMP INCLUDED	POWER	COLOUR TEMPERATURE	MODEL
 LED FILAMENT LAMP INCLUDED	6W	4000K 2700K	DR2.571.F1L DR2.571.F1R
	8W	4000K 2700K	DR2.571.M1L DR2.571.M1R
 LED FILAMENT LAMP INCLUDED	12W	4000K 2700K	DR2.571.N1L DR2.571.N1R

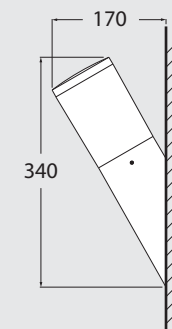

Master box: 20pcs

4 NEWS
28 BOLLARD
46 UP&DOWN
54 FLOODLIGHT
64 IN-GROUND
68 BRICKLIGHT
74 BULKHEAD
92 POST
96 LAMPS

ESTER

BOLLARD RANGE



DS1.564

CCT SETTABLE **NEW**

3000 K 4000 K 6500 K

SDCM <6



BOLLARD

ESTER

ESTER LED VERSIONS **NEW**

LAMP	POWER	LUMINOUS FLUX	VOLTAGE RANGE	KELVIN SETTABLE	INCANDESCENT EQUIVALENT
GX53	3W	350Lm	100-240V 50/60 Hz	6500K/4000K/3000K	40W
GX53	7W	800Lm	100-240V 50/60 Hz	6500K/4000K/3000K	75W
GX53	10W	1200Lm	100-240V 50/60 Hz	6500K/4000K/3000K	100W

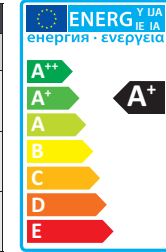

AVAILABLE COLORS

RESIN BODY + STEPPED REFLECTOR
(MOULDED COLOURS)

BLACK (A)	GREY (L)	WHITE (W)	CLEAR (X)

DIFFUSER

CLEAR (X)

ESTER 800

LED GX53 LAMP INCLUDED	POWER	MODEL
3W	3W	DS1.564.G1K
7W	7W	DS1.564.C1K
CCT SET	10W	DS1.564.D1K

NEW VERSION CCT SETTABLE LAMP Master box: 6pcs

ESTER 500

LED GX53 LAMP INCLUDED	POWER	MODEL
3W	3W	DS1.563.G1K
7W	7W	DS1.563.C1K
CCT SET	10W	DS1.563.D1K

NEW VERSION CCT SETTABLE LAMP Master box: 12pcs

ESTER WALL

LED GX53 LAMP INCLUDED	POWER	MODEL
3W	3W	DS1.560.G1K
7W	7W	DS1.560.C1K
CCT SET	10W	DS1.560.D1K

NEW VERSION CCT SETTABLE LAMP Master box: 18pcs

ESTER SPIKE

LED GX53 LAMP INCLUDED	POWER	MODEL
3W	3W	DS1.561.G1K
7W	7W	DS1.561.C1K
CCT SET	10W	DS1.561.D1K

NEW VERSION CCT SETTABLE LAMP Master box: 18pcs

4 NEWS
28 BOLLARD
46 UP&DOWN
54 FLOODLIGHT
64 IN-GROUND
68 BRICKLIGHT
74 BULKHEAD
92 POST
96 LAMPS

ELISA

BOLLARD RANGE



MADE IN ITALY



DS2.564

CCT SETTABLE **NEW**

3000 K 4000 K 6500 K

SDCM <6



BOLLARD

ELISA

ELISA LED VERSIONS **NEW**

LAMP	POWER	LUMINOUS FLUX	VOLTAGE RANGE	KELVIN SETTABLE	INCANDESCENT EQUIVALENT
GX53	3W	350Lm	100-240V 50/60 Hz	6500K/4000K/3000K	40W INCANDESCENT
GX53	7W	800Lm	100-240V 50/60 Hz	6500K/4000K/3000K	75W INCANDESCENT
GX53	10W	1200Lm	100-240V 50/60 Hz	6500K/4000K/3000K	100W INCANDESCENT

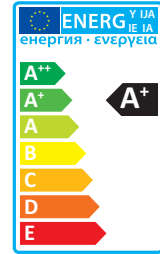

AVAILABLE COLORS

RESIN BODY (MOULDED COLOURS)

BLACK (A) GREY (L) WHITE (W)

DIFFUSER

CLEAR (X)

WITH WHITE RESIN REFLECTOR

ELISA 800

LED GX53 LAMP INCLUDED	POWER	MODEL
3W	3W	DS2.564.G1K
7W	7W	DS2.564.C1K
10W	10W	DS2.564.D1K

CCT SET

Technical drawing dimensions: 126 (width), 800 (height), 175 (base width)

NEW VERSION CCT SETTABLE LAMP Master box: 6pcs

ELISA 500

LED GX53 LAMP INCLUDED	POWER	MODEL
3W	3W	DS2.563.G1K
7W	7W	DS2.563.C1K
10W	10W	DS2.563.D1K

CCT SET

Technical drawing dimensions: 126 (width), 480 (height), 175 (base width)

NEW VERSION CCT SETTABLE LAMP Master box: 12pcs

ELISA WALL

LED GX53 LAMP INCLUDED	POWER	MODEL
3W	3W	DS2.560.G1K
7W	7W	DS2.560.C1K
10W	10W	DS2.560.D1K

CCT SET

Technical drawing dimensions: 126 (width), 165 (height)

NEW VERSION CCT SETTABLE LAMP Master box: 18pcs

ELISA SPIKE

LED GX53 LAMP INCLUDED	POWER	MODEL
3W	3W	DS2.561.G1K
7W	7W	DS2.561.C1K
10W	10W	DS2.561.D1K

CCT SET

Technical drawing dimensions: 126 (width), 165 (height), 175 (spike height)

NEW VERSION CCT SETTABLE LAMP Master box: 18pcs

4 NEWS
28 BOLLARD
46 UP&DOWN
54 FLOODLIGHT
64 IN-GROUND
68 BRICKLIGHT
74 BULKHEAD
92 POST
96 LAMPS

GABRI-MINIGABRI REMI/LUCIA

BOLLARD



MADE IN ITALY



1R3.613.X10



BOLLARD

GABRI-MINIGABRI REMI/LUCIA

LED BULKHEAD GX53					
LAMP	POWER	LUMINOUS FLUX	VOLTAGE RANGE	COLOUR TEMPERATURE	
	7W	600Lm	100-240V 50/60 Hz	4000K	≈ 60W INCANDESCENT
	11W	1300Lm	100-240V 50/60 Hz	4000K	≈ 100W INCANDESCENT
	18W	2000Lm	100-240V 50/60 Hz	4000K	≈ 150W INCANDESCENT



AVAILABLE COLORS			
RESIN BODY (MOULDED COLOURS)			DIFFUSER
BLACK (A)	GREY (L)	WHITE (W)	OPAL (Y)

GABRI REMI/LUCIA 1L

E27		1V3.613.X10.E27	2V3.613.X10.E27	3V3.613.X10.E27
GX53 LED	4000K	1V3.613.X10.A1L	2V3.613.X10.A1L	3V3.613.X10.A1L
	7W 3000K	1V3.613.X10.A1R	2V3.613.X10.A1R	3V3.613.X10.A1R
GX53 LED	4000K	1V3.613.X10.B1L	2V3.613.X10.B1L	3V3.613.X10.B1L
	11W 3000K	1V3.613.X10.B1R	2V3.613.X10.B1R	3V3.613.X10.B1R
GX53 LED	4000K	1V3.613.X10.E1L	2V3.613.X10.E1L	3V3.613.X10.E1L
	18W 3000K	1V3.613.X10.E1R	2V3.613.X10.E1R	3V3.613.X10.E1R

GABRI REMI/LUCIA 2L

E27		1V3.613.X20.E27	2V3.613.X20.E27	3V3.613.X20.E27
GX53 LED	4000K	1V3.613.X20.A1L	2V3.613.X20.A1L	3V3.613.X20.A1L
	7W 3000K	1V3.613.X20.A1R	2V3.613.X20.A1R	3V3.613.X20.A1R
GX53 LED	4000K	1V3.613.X20.B1L	2V3.613.X20.B1L	3V3.613.X20.B1L
	11W 3000K	1V3.613.X20.B1R	2V3.613.X20.B1R	3V3.613.X20.B1R
GX53 LED	4000K	1V3.613.X20.E1L	2V3.613.X20.E1L	3V3.613.X20.E1L
	18W 3000K	1V3.613.X20.E1R	2V3.613.X20.E1R	3V3.613.X20.E1R

MINIGABRI REMI/LUCIA 1L

E27		1V3.612.X10.E27	2V3.612.X10.E27	3V3.612.X10.E27
GX53 LED	4000K	1V3.612.X10.A1L	2V3.612.X10.A1L	3V3.612.X10.A1L
	7W 3000K	1V3.612.X10.A1R	2V3.612.X10.A1R	3V3.612.X10.A1R
GX53 LED	4000K	1V3.612.X10.B1L	2V3.612.X10.B1L	3V3.612.X10.B1L
	11W 3000K	1V3.612.X10.B1R	2V3.612.X10.B1R	3V3.612.X10.B1R
GX53 LED	4000K	1V3.612.X10.E1L	2V3.612.X10.E1L	3V3.612.X10.E1L
	18W 3000K	1V3.612.X10.E1R	2V3.612.X10.E1R	3V3.612.X10.E1R

MINIGABRI REMI/LUCIA 2L

E27		1V3.612.X20.E27	2V3.612.X20.E27	3V3.612.X20.E27
GX53 LED	4000K	1V3.612.X20.A1L	2V3.612.X20.A1L	3V3.612.X20.A1L
	7W 3000K	1V3.612.X20.A1R	2V3.612.X20.A1R	3V3.612.X20.A1R
GX53 LED	4000K	1V3.612.X20.B1L	2V3.612.X20.B1L	3V3.612.X20.B1L
	11W 3000K	1V3.612.X20.B1R	2V3.612.X20.B1R	3V3.612.X20.B1R
GX53 LED	4000K	1V3.612.X20.E1L	2V3.612.X20.E1L	3V3.612.X20.E1L
	18W 3000K	1V3.612.X20.E1R	2V3.612.X20.E1R	3V3.612.X20.E1R

MADE IN ITALY

4 NEWS
28 BOLLARD
46 UP&DOWN
54 FLOODLIGHT
64 IN-GROUND
68 BRICKLIGHT
74 BULKHEAD
92 POST
96 LAMPS

GABRI-MINIGABRI REMI/MADDI

BOLLARD

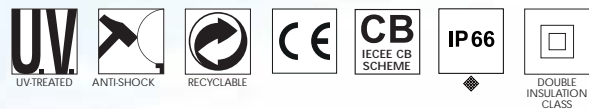

MADE IN ITALY



1V3.613.X10



BOLLARD

GABRI-MINIGABRI REMI/MADDI

LED BULKHEAD GX53					
LAMP	POWER	LUMINOUS FLUX	VOLTAGE RANGE	COLOUR TEMPERATURE	
	7W	600Lm	100-240V 50/60 Hz	4000K 3000K	60W INCANDESCENT
	11W	1300Lm	100-240V 50/60 Hz	4000K 3000K	100W INCANDESCENT
	18W	2000Lm	100-240V 50/60 Hz	4000K 3000K	150W INCANDESCENT

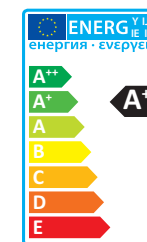

AVAILABLE COLORS			
RESIN BODY (MOULDED COLOURS)			DIFFUSER
BLACK (A)	GREY (L)	WHITE (W)	OPAL (Y)

GABRI REMI/MADDI 1L

E27		1V3.613.X10.E27	2V3.613.X10.E27	3V3.613.X10.E27
GX53 LED 7W 3000K	4000K	1V3.613.X10.A1L	2V3.613.X10.A1L	3V3.613.X10.A1L
	3000K	1V3.613.X10.A1R	2V3.613.X10.A1R	3V3.613.X10.A1R
GX53 LED 11W 3000K	4000K	1V3.613.X10.B1L	2V3.613.X10.B1L	3V3.613.X10.B1L
	3000K	1V3.613.X10.B1R	2V3.613.X10.B1R	3V3.613.X10.B1R
GX53 LED 18W 3000K	4000K	1V3.613.X10.E1L	2V3.613.X10.E1L	3V3.613.X10.E1L
	3000K	1V3.613.X10.E1R	2V3.613.X10.E1R	3V3.613.X10.E1R

GABRI REMI/MADDI 2L

E27		1V3.613.X20.E27	2V3.613.X20.E27	3V3.613.X20.E27
GX53 LED 7W 3000K	4000K	1V3.613.X20.A1L	2V3.613.X20.A1L	3V3.613.X20.A1L
	3000K	1V3.613.X20.A1R	2V3.613.X20.A1R	3V3.613.X20.A1R
GX53 LED 11W 3000K	4000K	1V3.613.X20.B1L	2V3.613.X20.B1L	3V3.613.X20.B1L
	3000K	1V3.613.X20.B1R	2V3.613.X20.B1R	3V3.613.X20.B1R
GX53 LED 18W 3000K	4000K	1V3.613.X20.E1L	2V3.613.X20.E1L	3V3.613.X20.E1L
	3000K	1V3.613.X20.E1R	2V3.613.X20.E1R	3V3.613.X20.E1R

MINIGABRI REMI/MADDI 1L

E27		1V3.612.X10.E27	2V3.612.X10.E27	3V3.612.X10.E27
GX53 LED 7W 3000K	4000K	1V3.612.X10.A1L	2V3.612.X10.A1L	3V3.612.X10.A1L
	3000K	1V3.612.X10.A1R	2V3.612.X10.A1R	3V3.612.X10.A1R
GX53 LED 11W 3000K	4000K	1V3.612.X10.B1L	2V3.612.X10.B1L	3V3.612.X10.B1L
	3000K	1V3.612.X10.B1R	2V3.612.X10.B1R	3V3.612.X10.B1R
GX53 LED 18W 3000K	4000K	1V3.612.X10.E1L	2V3.612.X10.E1L	3V3.612.X10.E1L
	3000K	1V3.612.X10.E1R	2V3.612.X10.E1R	3V3.612.X10.E1R

MINIGABRI REMI/MADDI 2L

E27		1V3.612.X20.E27	2V3.612.X20.E27	3V3.612.X20.E27
GX53 LED 7W 3000K	4000K	1V3.612.X20.A1L	2V3.612.X20.A1L	3V3.612.X20.A1L
	3000K	1V3.612.X20.A1R	2V3.612.X20.A1R	3V3.612.X20.A1R
GX53 LED 11W 3000K	4000K	1V3.612.X20.B1L	2V3.612.X20.B1L	3V3.612.X20.B1L
	3000K	1V3.612.X20.B1R	2V3.612.X20.B1R	3V3.612.X20.B1R
GX53 LED 18W 3000K	4000K	1V3.612.X20.E1L	2V3.612.X20.E1L	3V3.612.X20.E1L
	3000K	1V3.612.X20.E1R	2V3.612.X20.E1R	3V3.612.X20.E1R

MADE IN ITALY

4 NEWS
28 BOLLARD
46 UP&DOWN
54 FLOODLIGHT
64 IN-GROUND
68 BRICKLIGHT
74 BULKHEAD
92 POST
96 LAMPS

PINELA-MINIPINELA

BOLLARD



MADE IN ITALY



2N1.613.010

CCT SETTABLE **NEW**

3000 K 4000 K 6500 K

SDCM <6



BOLLARD

PINELA-MINIPINELA

GERMANA LED VERSIONS **NEW**

LAMP	POWER	LUMINOUS FLUX	VOLTAGE RANGE	CCT SETTABLE	INCANDESCENT
2x GX53	2x3W 6W	700Lm	100-240V 50/60 Hz	6500K / 4000K / 3000K	= 75W
2x GX53	2x7W 14W	1600Lm	100-240V 50/60 Hz	6500K / 4000K / 3000K	= 100W
2x GX53	2x10W 20W	2400Lm	100-240V 50/60 Hz	6500K / 4000K / 3000K	= 150W



AVAILABLE COLORS

RESIN BODY (MOULDED COLOURS)			DIFFUSER
BLACK (A)	GREY (L)	WHITE (W)	OPAL (Y)

PINELA 1L

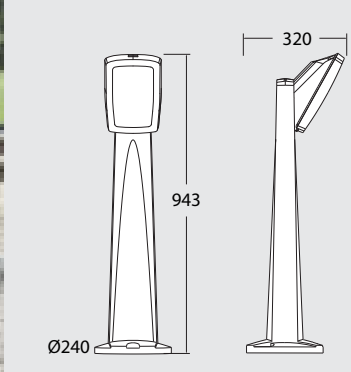

E27		2N1.613.010.P27
2x3W 6W	CCT SET	2N1.613.010.G2K
2x7W 14W	CCT SET	2N1.613.010.C2K
2x10W 20W	CCT SET	2N1.613.010.D2K

PINELA 2L

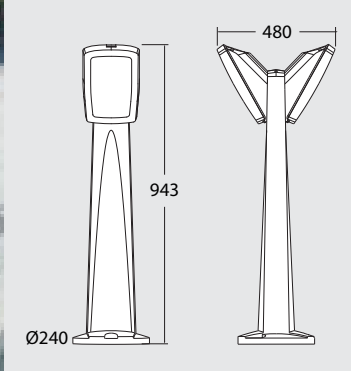

E27		2N1.613.020.P27
2x 6W	CCT SET	2N1.613.020.G2K
2x 14W	CCT SET	2N1.613.020.C2K
2x 20W	CCT SET	2N1.613.020.D2K

MINIPINELA 1L

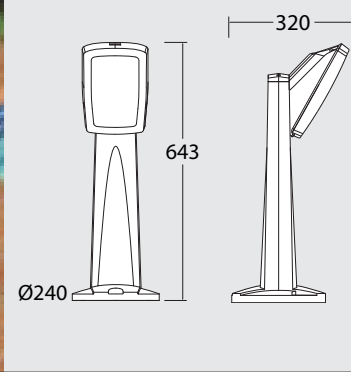
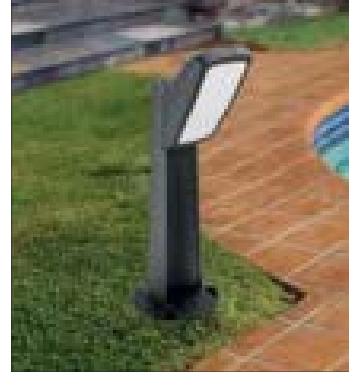

E27		2N1.612.010.P27
2x3W 6W	CCT SET	2N1.612.010.G2K
2x7W 14W	CCT SET	2N1.612.010.C2K
2x10W 20W	CCT SET	2N1.612.010.D2K

MINIPINELA 2L

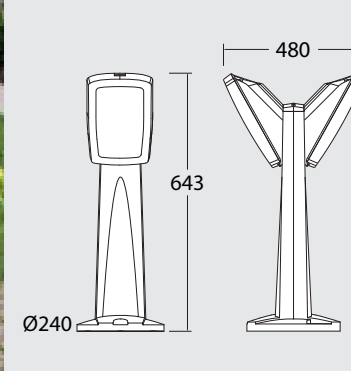

E27		2N1.612.020.P27
2x 6W	CCT SET	2N1.612.020.G2K
2x 14W	CCT SET	2N1.612.020.C2K
2x 20W	CCT SET	2N1.612.020.D2K

MADE IN ITALY

4 NEWS
28 BOLLARD
46 UP&DOWN
54 FLOODLIGHT
64 IN-GROUND
68 BRICKLIGHT
74 BULKHEAD
92 POST
96 LAMPS

FRANCA 90

UP&DOWN



MADE IN ITALY



3A7.002.U1K

CCT SETTABLE **NEW**

2700 K 4000 K

SDCM <6



UP&DOWN

FRANCA 90

FRANCA 90 LED VERSIONS					
LAMP	POWER	LUMINOUS FLUX	VOLTAGE RANGE	CCT SETTABLE	
FRANCA 90 1L	3,5W NEW	350Lm	100-240V 50/60 Hz	4000K/2700K	= 50W HALOGEN
FRANCA 90 2L	2x 3,5W 7W NEW	700Lm	100-240V 50/60 Hz	4000K/2700K	= 2 x 50W HALOGEN
FRANCA 90 2L	2x 6W 12W NEW	1200Lm	100-240V 50/60 Hz	4000K/2700K	= 2 x 100W HALOGEN

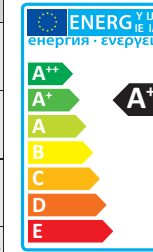

AVAILABLE COLORS

RESIN BODY (MOULDED COLOURS)

BLACK (A) GREY (L) WHITE (W)

DIFFUSER

FROSTED (X) BLUE (U)
GREEN (N) ORANGE (R)

FRANCA 90

LED GU10 LAMP INCLUDED	3,5W	3A7.000.U1K
CCT SET	6W NEW	3A7.000.L1K

NEW VERSION CCT SETTABLE LAMP Master box: 30pcs

FRANCA 90 SPIKE

LED GU10 LAMP INCLUDED	3,5W	3A7.001.U1K
CCT SET	6W NEW	3A7.001.L1K

NEW VERSION CCT SETTABLE LAMP Master box: 30pcs

FRANCA 90-1L WALL

LED GU10 LAMP INCLUDED	3,5W	3A7.002.U1K
CCT SET	6W NEW	3A7.002.L1K

NEW VERSION CCT SETTABLE LAMP Master box: 30pcs

FRANCA 90-2L WALL

LED GU10 LAMP INCLUDED	2x3,5W 7W	3A7.003.U2K
CCT SET	2x6W 12W NEW	3A7.003.L2K

NEW VERSION CCT SETTABLE LAMP Master box: 20pcs

4 NEWS
28 BOLLARD
46 UP&DOWN
54 FLOODLIGHT
64 IN-GROUND
68 BRICKLIGHT
74 BULKHEAD
92 POST
96 LAMPS

MARTA 90

UP&DOWN



MADE IN ITALY



2A4.000

CCT SETTABLE **NEW**

2700 K 4000 K

SDCM <6



UP&DOWN

MARTA 90

MARTA90 LED VERSIONS					
LAMP	POWER	LUMINOUS FLUX	VOLTAGE RANGE	CCT SETTABLE	NEW
MARTA 90 1L GU10 LED	3,5W	350Lm	100-240V 50/60 Hz	4000K/2700K	= 1x 50W HALOGEN
MARTA 90 1L GU10 LED	6W	600Lm	100-240V 50/60 Hz	4000K/2700K	= 1x 100W HALOGEN
MARTA 90 2L 2x GU10 LED	2x 3,5W 7W	700 Lm	100-240V 50/60 Hz	4000K/2700K	= 2 x 50W HALOGEN
MARTA 90 2L 2x GU10 LED	2x 6W 12W	1200Lm	100-240V 50/60 Hz	4000K/2700K	= 2 x 100W HALOGEN

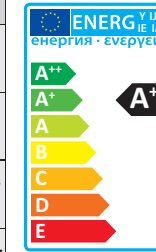

AVAILABLE COLORS

RESIN BODY (MOULDED COLOURS)

BLACK (A) GREY (L) WHITE (W)

DIFFUSER

FROSTED (X) BLUE (U)
GREEN (N) ORANGE (R)

MARTA90 1L

LED GU10 LAMP INCLUDED CCT SET

3,5W	1A4.000.U1K
6W NEW	1A4.000.L1K

NEW VERSION CCT SETTABLE LAMP

Master box: 36pcs

MARTA90 2L

LED GU10 LAMP INCLUDED CCT SET

2x3,5W 7W	2A4.000.U2K
2x6W 12W NEW	2A4.000.L2K

NEW VERSION CCT SETTABLE LAMP

Master box: 36pcs

4 NEWS
28 BOLLARD
46 UP&DOWN
54 FLOODLIGHT
64 IN-GROUND
68 BRICKLIGHT
74 BULKHEAD
92 POST
96 LAMPS

MARTA 160

UP&DOWN



MADE IN ITALY



1A6.000

CCT SETTABLE **NEW**

3000 K 4000 K 6500 K

SDCM <6



UP&DOWN

MARTA 160

MARTA160 LED VERSIONS **NEW**

LAMP	POWER	LUMINOUS FLUX	VOLTAGE RANGE	CCT SETTABLE	INCANDESCENT
MARTA160 1L GX53	3W	350Lm	100-240V 50/60 Hz	6500K/4000K/3000K	40W
	7W	800Lm	100-240V 50/60 Hz	6500K/4000K/3000K	75W
	10W	1200Lm	100-240V 50/60 Hz	6500K/4000K/3000K	100W
MARTA160 2L 2x GX53	2x3W 6W	700Lm	100-240V 50/60 Hz	6500K/4000K/3000K	2x40W
	2x7W 14W	1600Lm	100-240V 50/60 Hz	6500K/4000K/3000K	2x75W
	2x10W 20W	2400Lm	100-240V 50/60 Hz	6500K/4000K/3000K	2x100W
					INCANDESCENT

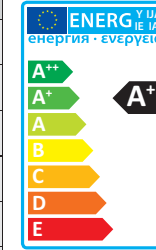

AVAILABLE COLORS

RESIN BODY (MOULDED COLOURS)

BLACK (A) GREY (L) WHITE (W)

DIFFUSER

FROSTED (X) BLUE (U)
GREEN (N) ORANGE (R)

MARTA160 1L

E27	1A6.000.E27
3W	1A6.000.G1K
7W	1A6.000.C1K
10W	1A6.000.D1K

LED GX53 LAMP INCLUDED
CCT SET

NEW VERSION CCT SETTABLE LAMP

Master box: 18pcs

MARTA160 2L

2x3W 6W	2A6.000.G2K
2x7W 14W	2A6.000.C2K
2x10W 20W	2A6.000.D2K

LED GX53 LAMP INCLUDED
CCT SET

NEW VERSION CCT SETTABLE LAMP

Master box: 18pcs

4 NEWS
28 BOLLARD
46 UP&DOWN
54 FLOODLIGHT
64 IN-GROUND
68 BRICKLIGHT
74 BULKHEAD
92 POST
96 LAMPS

FRANCY UP&DOWN



MADE IN ITALY



1A1.000.F1R



UP&DOWN

FRANCY

FRANCY LED VERSIONS					
LAMP	POWER	LUMINOUS FLUX	VOLTAGE RANGE	COLOUR TEMPERATURE	
FILAMENT LED E27	6W	800Lm	100-240V 50/60 Hz	4000K 2700K	= 60W INCANDESCENT
2x G5.3 LED	2x3W 6W	700Lm	100-240V 50/60 Hz	6500K/4000K/3000K	= 75W INCANDESCENT

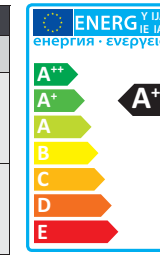

AVAILABLE COLORS			
RESIN BODY (MOULDED COLOURS)			DIFFUSER
BLACK (A)	GREY (L)	WHITE (W)	OPAL (Y)

FRANCY			
LED FILAMENT LAMP INCLUDED	6W	4000K	1A1.000.F1L
		2700K	1A1.000.F1R
	6W+ SENSOR	4000K	1A1.000.S1L
		2700K	1A1.000.S1R

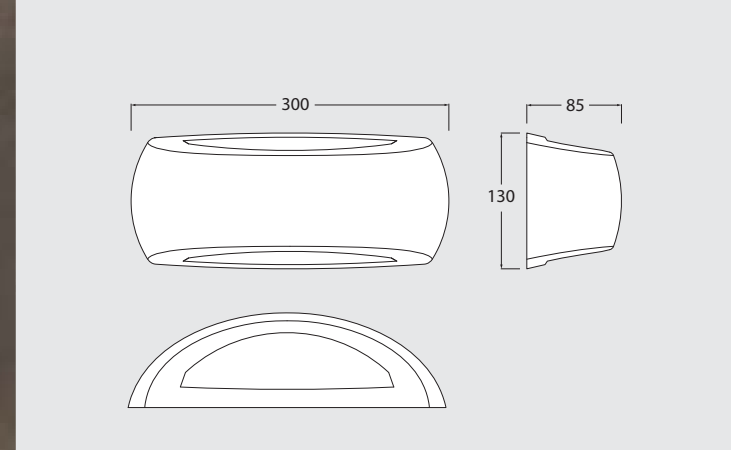

AVAILABLE VERSIONS SUPPLIED FULLY PRE-WIRED	
FILAMENT LED	FILAMENT LED + SENSOR

Master box: 24pcs

FRANCY-OP		
E27		2A1.000.E27
6W FILAMENT LED	4000K	2A1.000.F1L
	2700K	2A1.000.F1R
2x3W 6W	CCT SET	2A1.000.G2K
E27 WITH SENSOR	220-240V	2A1.000.ES7

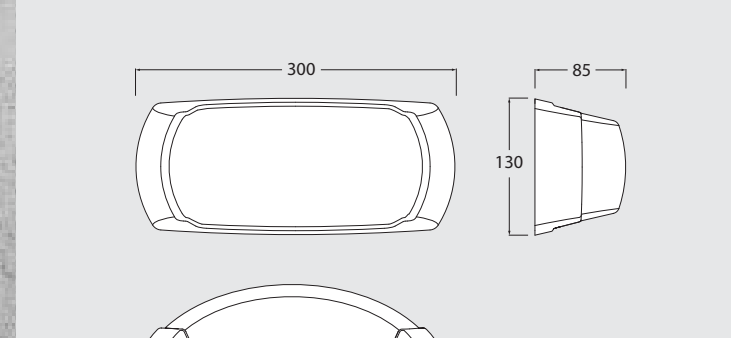

AVAILABLE VERSIONS SUPPLIED FULLY PRE-WIRED	
E27	

Master box: 24pcs

MADE IN ITALY

4 NEWS
28 BOLLARD
46 UP&DOWN
54 FLOODLIGHT
64 IN-GROUND
68 BRICKLIGHT
74 BULKHEAD
92 POST
96 LAMPS

MINITOMMY FLOODLIGHT



MADE IN ITALY



1M1.001

CCT SETTABLE **NEW**

2700 K 4000 K

SDCM <6



FLOODLIGHT

MINITOMMY

MINITOMMY LED VERSIONS					
LAMP	POWER	LUMINOUS FLUX	VOLTAGE RANGE	CCT SETTABLE	NEW
MINITOMMY 1L GU10 LED	3,5W	350Lm	100-240V 50/60 Hz	4000K/2700K	= 50W HALOGEN
MINITOMMY 1L GU10 LED	6W	600Lm	100-240V 50/60 Hz	4000K/2700K	= 100W HALOGEN
MINITOMMY 2L 2x GU10 LED	2x 3,5W 7W	700 Lm	100-240V 50/60 Hz	4000K/2700K	= 2 x 50W HALOGEN
MINITOMMY 2L 2x GU10 LED	2x 6W 12W	1200Lm	100-240V 50/60 Hz	4000K/2700K	= 2 x 100W HALOGEN

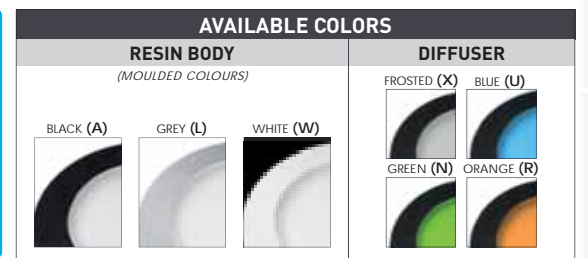

MINITOMMY

LED GU10 LAMP INCLUDED
CCT SET

FULLY ADJUSTABLE POSITION

NEW VERSION CCT SETTABLE LAMP

POWER	MODEL
3,5W	1M1.000.U1K
6W NEW	1M1.000.L1K

MINITOMMY SPIKE

LED GU10 LAMP INCLUDED
CCT SET

FULLY ADJUSTABLE POSITION

NEW VERSION CCT SETTABLE LAMP

POWER	MODEL
3,5W	1M1.001.U1K
6W NEW	1M1.001.L1K

MINITOMMY-EL

LED GU10 LAMP INCLUDED
CCT SET

FULLY ADJUSTABLE POSITION

NEW VERSION CCT SETTABLE LAMP

POWER	MODEL
3,5W	1M2.000.U1K
6W NEW	1M2.000.L1K

MINITOMMY-EL SPIKE

LED GU10 LAMP INCLUDED
CCT SET

FULLY ADJUSTABLE POSITION

NEW VERSION CCT SETTABLE LAMP

POWER	MODEL
3,5W	1M2.001.U1K
6W NEW	1M2.001.L1K

MINITOMMY 2L

LED GU10 LAMP INCLUDED
CCT SET

FULLY ADJUSTABLE POSITION

NEW VERSION CCT SETTABLE LAMP

LAMP	POWER	MODEL
2x GU10 LED	2x 3,5W	3M1.000.U2K
2x GU10 LED	2x 6W NEW	3M1.000.L2K

MINITOMMY 2L SPIKE

LED GU10 LAMP INCLUDED
CCT SET

FULLY ADJUSTABLE POSITION

NEW VERSION CCT SETTABLE LAMP

LAMP	POWER	MODEL
2x GU10 LED	2x 3,5W	3M1.001.U2K
2x GU10 LED	2x 6W NEW	3M1.001.L2K

MINITOMMY-EL 2L

LED GU10 LAMP INCLUDED
CCT SET

FULLY ADJUSTABLE POSITION

NEW VERSION CCT SETTABLE LAMP

LAMP	POWER	MODEL
2x GU10 LED	2x 3,5W	3M2.000.U2K
2x GU10 LED	2x 6W NEW	3M2.000.L2K

MINITOMMY-EL 2L SPIKE

LED GU10 LAMP INCLUDED
CCT SET

FULLY ADJUSTABLE POSITION

NEW VERSION CCT SETTABLE LAMP

LAMP	POWER	MODEL
2x GU10 LED	2x 3,5W	3M2.001.U2K
2x GU10 LED	2x 6W NEW	3M2.001.L2K

MADE IN ITALY

4 NEWS
28 BOLLARD
46 UP&DOWN
54 FLOODLIGHT
64 IN-GROUND
68 BRICKLIGHT
74 BULKHEAD
92 POST
96 LAMPS

TOMMY FLOODLIGHT



MADE IN ITALY



2M1.000

CCT SETTABLE **NEW**

3000 K 4000 K 6500 K

SDCM <6



FLOODLIGHT

TOMMY

TOMMY LED VERSIONS **NEW**

LAMP	POWER	LUMINOUS FLUX	VOLTAGE RANGE	CCT SETTABLE	INCANDESCENT
GX53	3W	350Lm	100-240V 50/60 Hz	6500K/4000K/3000K	40W
GX53	7W	800Lm	100-240V 50/60 Hz	6500K/4000K/3000K	75W
GX53	10W	1200Lm	100-240V 50/60 Hz	6500K/4000K/3000K	100W

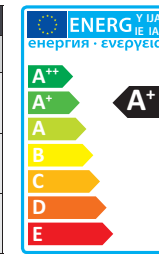

TOMMY-SQ **TOMMY-SQ SPIKE**

LED GX53 LAMP INCLUDED	CCT SET	3W	7W	10W	3W	7W	10W
		5M1.000.G1K	5M1.000.C1K	5M1.000.D1K	5M1.001.G1K	5M1.001.C1K	5M1.001.D1K

NEW VERSION CCT SETTABLE LAMP

Master box: 18pcs



TOMMY **TOMMY SPIKE**

LED GX53 LAMP INCLUDED	CCT SET	3W	7W	10W	3W	7W	10W
		2M1.000.G1K	2M1.000.C1K	2M1.000.D1K	2M1.001.G1K	2M1.001.C1K	2M1.001.D1K

NEW VERSION CCT SETTABLE LAMP

Master box: 18pcs

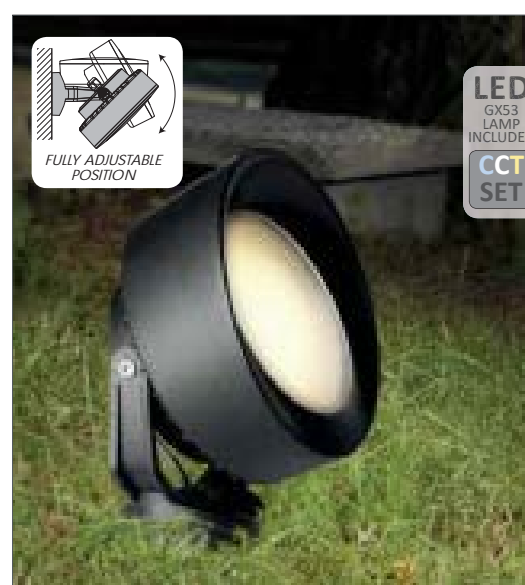

TOMMY-EL **TOMMY-EL SPIKE**

LED GX53 LAMP INCLUDED	CCT SET	3W	7W	10W	3W	7W	10W
		2M2.000.G1K	2M2.000.C1K	2M2.000.D1K	2M2.001.G1K	2M2.001.C1K	2M2.001.D1K

NEW VERSION CCT SETTABLE LAMP

Master box: 18pcs

4 NEWS
28 BOLLARD
46 UP&DOWN
54 FLOODLIGHT
64 IN-GROUND
68 BRICKLIGHT
74 BULKHEAD
92 POST
96 LAMPS

TOMMY 2L FLOODLIGHT



MADE IN ITALY

4M1.001



CCT SETTABLE NEW

3000 K 4000 K 6500 K

SDCM <6



FLOODLIGHT

TOMMY 2L

TOMMY-2L LED VERSIONS NEW

LAMP	POWER	LUMINOUS FLUX	VOLTAGE RANGE	CCT SETTABLE	INCANDESCENT EQUIVALENT
2x GX53	2x3W 6W	700Lm	100-240V 50/60 Hz	6500K/4000K/3000K	= 75W INCANDESCENT
2x GX53	2x7W 14W	1600Lm	100-240V 50/60 Hz	6500K/4000K/3000K	= 100W INCANDESCENT
2x GX53	2x10W 20W	2400Lm	100-240V 50/60 Hz	6500K/4000K/3000K	= 150W INCANDESCENT

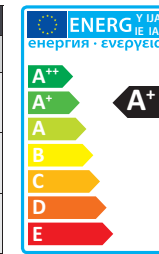

TOMMY-SQ 2L

2x 3W	6M1.000.G2K
2x 7W	6M1.000.C2K
2x 10W	6M1.000.D2K

NEW VERSION CCT SETTABLE LAMP

Master box: 8pcs

TOMMY-SQ 2L SPIKE

2x 3W	6M1.001.G2K
2x 7W	6M1.001.C2K
2x 10W	6M1.001.D2K

Master box: 8pcs



TOMMY 2L

2x 3W	4M1.000.G2K
2x 7W	4M1.000.C2K
2x 10W	4M1.000.D2K

NEW VERSION CCT SETTABLE LAMP

Master box: 8pcs

TOMMY 2L SPIKE

2x 3W	4M1.001.G2K
2x 7W	4M1.001.C2K
2x 10W	4M1.001.D2K

Master box: 8pcs



TOMMY-EL 2L

2x 3W	4M2.000.G2K
2x 7W	4M2.000.C2K
2x 10W	4M2.000.D2K

NEW VERSION CCT SETTABLE LAMP

Master box: 8pcs

TOMMY-EL 2L SPIKE

2x 3W	4M2.001.G2K
2x 7W	4M2.001.C2K
2x 10W	4M2.001.D2K

Master box: 8pcs

MADE IN ITALY

4 NEWS
28 BOLLARD
46 UP&DOWN
54 FLOODLIGHT
64 IN-GROUND
68 BRICKLIGHT
74 BULKHEAD
92 POST
96 LAMPS
98

GERMANA FLOODLIGHT



MADE IN ITALY



2N1.000

CCT SETTABLE **NEW**

3000 K 4000 K 6500 K

SDCM <6

SUPPLIED FULLY PRE-WIRED

2x GX53 LED	E27	E27 + SENSOR
-------------	-----	--------------

WITH SENSOR)))
220-240V
(.PS7)



FLOODLIGHT

GERMANA

GERMANA LED VERSIONS **NEW**

LAMP	POWER	LUMINOUS FLUX	VOLTAGE RANGE	CCT SETTABLE	INCANDESCENT
2x GX53	2x3W 6W	700Lm	100-240V 50/60 Hz	6500K/4000K/3000K	= 75W
2x GX53	2x7W 14W	1600Lm	100-240V 50/60 Hz	6500K/4000K/3000K	= 100W
2x GX53	2x10W 20W	2400Lm	100-240V 50/60 Hz	6500K/4000K/3000K	= 150W



AVAILABLE COLORS

RESIN BODY (MOULDED COLOURS)			DIFFUSER
BLACK (A)	GREY (L)	WHITE (W)	OPAL (Y)

GERMANA

E27	2N1.000.P27
2x3W 6W	2N1.000.G2K
2x7W 14W	2N1.000.C2K
2x10W 20W	2N1.000.D2K

LED GX53 LAMP INCLUDED
CCT SET

NEW VERSION CCT SETTABLE LAMP

Master box: 18pcs

GIOVA/GERMANA

E27	2N1.702.P27
2x3W 6W	2N1.702.G2K
2x7W 14W	2N1.702.C2K
2x10W 20W	2N1.702.D2K

LED GX53 LAMP INCLUDED
CCT SET

NEW VERSION CCT SETTABLE LAMP

Master box: 18pcs

4 NEWS
28 BOLLARD
46 UP&DOWN
54 FLOODLIGHT
64 IN-GROUND
68 BRICKLIGHT
74 BULKHEAD
92 POST
96 LAMPS

GIUSEPPE FLOODLIGHT

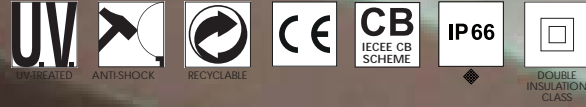

MADE IN ITALY



4P2.000

SUPPLIED FULLY PRE-WIRED

GX53 LED	GX53 LED + SENSOR	4x GX53 LED	2x E27	2x E27 + SENSOR
	WITH SENSOR))) (220-240V) 7W 4000K (.ASL) 7W 3000K (.ASR) 11W 4000K (.BSL) 11W 3000K (.BSR) 18W 4000K (.ESL) 18W 3000K (.ESR)			WITH SENSOR))) 220-240V (.ES8)



FLOODLIGHT

GIUSEPPE

GIUSEPPE LED VERSIONS					
LAMP	POWER	LUMINOUS FLUX	VOLTAGE RANGE	COLOUR TEMPERATURE	
	7W	600Lm	100-240V 50/60 Hz	4000K 3000K	= 60W INCANDESCENT
	11W	1300Lm	100-240V 50/60 Hz	4000K 3000K	= 100W INCANDESCENT
	18W	2000Lm	100-240V 50/60 Hz	4000K 3000K	= 150W INCANDESCENT
	4x7W 28W	3200Lm	100-240V 50/60 Hz	6500K/4000K/3000K	= 70W HQI-SON
	4x10W 40W	4800Lm	100-240V 50/60 Hz	6500K/4000K/3000K	= 100W HQI-SON

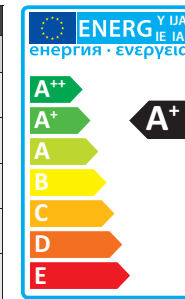

AVAILABLE COLORS			
RESIN BODY (MOULDED COLOURS)			DIFFUSER
BLACK (A)	GREY (L)	WHITE (W)	OPAL (Y)

GIUSEPPE

LED GX53 LAMP INCLUDED	2x E27	4P2.000.E28
7W 4000K 3000K	4000K 3000K	4P1.000.A1L 4P1.000.A1R
11W 4000K 3000K	4000K 3000K	4P1.000.B1L 4P1.000.B1R
18W 4000K 3000K	4000K 3000K	4P1.000.E1L 4P1.000.E1R
4x7W 28W CCT SET	CCT SET	4P2.000.C4K
4x10W 40W CCT SET	CCT SET	4P2.000.D4K

Master box: 10pcs

GIOVA/GIUSEPPE

LED GX53 LAMP INCLUDED	2x E27	4P2.702.E28
7W 4000K 3000K	4000K 3000K	4P1.702.A1L 4P1.702.A1R
11W 4000K 3000K	4000K 3000K	4P1.702.B1L 4P1.702.B1R
18W 4000K 3000K	4000K 3000K	4P1.702.E1L 4P1.702.E1R
4x7W 28W CCT SET	CCT SET	4P2.702.C4K
4x10W 40W CCT SET	CCT SET	4P2.702.D4K

Master box: 10pcs

MADE IN ITALY

4 NEWS
28 BOLLARD
46 UP&DOWN
54 FLOODLIGHT
64 IN-GROUND
68 BRICKLIGHT
74 BULKHEAD
92 POST
96 LAMPS

CECI
IN-GROUND



MADE IN ITALY



1F2.000

CCT SETTABLE **NEW**

2700 K 4000 K

SDCM <6



IN-GROUND

CECI 90

CECI 90 LED VERSIONS				
LAMP	POWER	LUMINOUS FLUX	VOLTAGE RANGE	CCT SETTABLE
GU10 LED	3,5W	350Lm	100-240V 50/60 Hz	4000K/2700K = 50W HALOGEN
GU10 LED	6W	600Lm	100-240V 50/60 Hz	4000K/2700K = 100W HALOGEN

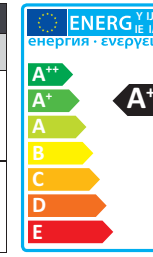

AVAILABLE COLORS	
COVER (MOULDED COLOURS)	DIFFUSER
BLACK (A) GREY (L)	FROSTED (X) BLUE (U) GREEN (N) ORANGE (R)

CECI 90

LED GU10 LAMP INCLUDED
CCT SET

3,5W	1F1.000.U1K
6W NEW	1F1.000.L1K

NEW VERSION CCT SETTABLE LAMP

Master box: 40pcs

CECI 90-2L

LED GU10 LAMP INCLUDED
CCT SET

3,5W	1F2.000.U1K
6W NEW	1F2.000.L1K

NEW VERSION CCT SETTABLE LAMP

Master box: 40pcs

CECI 90-3L

LED GU10 LAMP INCLUDED
CCT SET

3,5W	1F3.000.U1K
6W NEW	1F3.000.L1K

NEW VERSION CCT SETTABLE LAMP

Master box: 40pcs

CECI 90-SQ

LED GU10 LAMP INCLUDED
CCT SET

3,5W	1F4.000.U1K
6W NEW	1F4.000.L1K

NEW VERSION CCT SETTABLE LAMP

Master box: 40pcs

MADE IN ITALY

4 NEWS
28 BOLLARD
46 UP&DOWN
54 FLOODLIGHT
64 IN-GROUND
68 BRICKLIGHT
74 BULKHEAD
92 POST
96 LAMPS

AVAILABLE COLORS

COVER (MOULDED COLOURS)

BLACK (A) GREY (L)

DIFFUSER

FROSTED (X)

BLUE (U) GREEN (N) ORANGE (R)

CE

IP67

UV

DOUBLE INSULATION GLASS

ANTISHOCK

RECYCLABLE

CECI 120 LED VERSIONS				
LAMP	POWER	LUMINOUS FLUX	VOLTAGE RANGE	CCT SETTABLE
GX53	3W	350Lm	100-240V 50/60 Hz	6500K/4000K/3000K
				≈ 40W INCANDESCENT

CECI 120

LED GX53 LAMP INCLUDED

3W 2F1.000.G1K

120 93 117

NEW VERSION CCT SETTABLE LAMP

Master box: 36pcs

CECI 120-2L

LED GX53 LAMP INCLUDED

3W 2F2.000.G1K

120 93 117

NEW VERSION CCT SETTABLE LAMP

Master box: 36pcs

CECI 120-3L

LED GX53 LAMP INCLUDED

3W 2F3.000.G1K

120 93 117

NEW VERSION CCT SETTABLE LAMP

Master box: 36pcs

CECI 120-SQ

LED GX53 LAMP INCLUDED

3W 2F4.000.G1K

120 93 117

NEW VERSION CCT SETTABLE LAMP

Master box: 36pcs

ENERGY CLASS A+

TUV

TECEE

CECI 160 LED VERSIONS				
LAMP	POWER	LUMINOUS FLUX	VOLTAGE RANGE	CCT SETTABLE
GX53	7W	800Lm	100-240V 50/60 Hz	6500K/4000K/3000K
GX53	10W	1200Lm	100-240V 50/60 Hz	6500K/4000K/3000K
				≈ 75W INCANDESCENT
				≈ 100W INCANDESCENT

CECI 160

LED GX53 LAMP INCLUDED

7W 3F1.000.C1K

10W 3F1.000.D1K

160 111 147

NEW VERSION CCT SETTABLE LAMP

Master box: 18pcs

CECI 160-2L

LED GX53 LAMP INCLUDED

7W 3F2.000.C1K

10W 3F2.000.D1K

160 111 147

NEW VERSION CCT SETTABLE LAMP

Master box: 18pcs

CECI 160-3L

LED GX53 LAMP INCLUDED

7W 3F3.000.C1K

10W 3F23.000.D1K

160 111 147

NEW VERSION CCT SETTABLE LAMP

Master box: 18pcs

CECI 160-SQ

LED GX53 LAMP INCLUDED

7W 3F4.000.C1K

10W 3F4.000.D1K

160 111 147

NEW VERSION CCT SETTABLE LAMP

Master box: 18pcs

4 NEWS
28 BOLLARD
46 UP&DOWN
54 FLOODLIGHT
64 IN-GROUND
68 BRICKLIGHT
74 BULKHEAD
92 POST
96 LAMPS

LETI RANGE BRICKLIGHT



MADE IN ITALY



2C1.000

CCT SETTABLE **NEW**

3000 K 4000 K 6500 K

SDCM <6



BRICKLIGHT

LETI/EXTRALETI 100 ROUND

LETI/EXTRALETI 100 LED VERSIONS				
LAMP	POWER	LUMINOUS FLUX	VOLTAGE RANGE	CCT SETTABLE
	3W	350Lm	100-240V 50/60 Hz	6500K/4000K/3000K
				40W INCANDESCENT

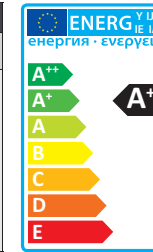

LETI 100 ROUND

CCT SET LED 3W GX53 LAMP INCLUDED

2C1.000.G1K

NEW VERSION CCT SETTABLE LAMP Master box: 48pcs

EXTRALETI 100 ROUND

CCT SET LED 3W GX53 LAMP INCLUDED

2S1.000.G1K

NEW VERSION CCT SETTABLE LAMP Master box: 48pcs

LETI 100 ROUND-GR

CCT SET LED 3W GX53 LAMP INCLUDED

2C2.000.G1K

NEW VERSION CCT SETTABLE LAMP Master box: 48pcs

EXTRALETI 100 ROUND-GR

CCT SET LED 3W GX53 LAMP INCLUDED

2S2.000.G1K

NEW VERSION CCT SETTABLE LAMP Master box: 48pcs

LETI 100 ROUND-EL

CCT SET LED 3W GX53 LAMP INCLUDED

2C3.000.G1K

NEW VERSION CCT SETTABLE LAMP Master box: 48pcs

EXTRALETI 100 ROUND-EL

CCT SET LED 3W GX53 LAMP INCLUDED

2S3.000.G1K

NEW VERSION CCT SETTABLE LAMP Master box: 48pcs

LETI 100 ROUND-ST

CCT SET LED 3W GX53 LAMP INCLUDED

2C4.000.G1K

NEW VERSION CCT SETTABLE LAMP Master box: 48pcs

EXTRALETI 100 ROUND-ST

CCT SET LED 3W GX53 LAMP INCLUDED

2S4.000.G1K

NEW VERSION CCT SETTABLE LAMP Master box: 48pcs

4 NEWS
28 BOLLARD
46 UP&DOWN
54 FLOODLIGHT
64 IN-GROUND
68 BRICKLIGHT
74 BULKHEAD
92 POST
96 LAMPS

LETI/EXTRALETI 100 SQUARE

BRICKLIGHT



LETI/EXTRALETI 100 LED VERSIONS				
LAMP	POWER	LUMINOUS FLUX	VOLTAGE RANGE	CCT SETTABLE
	3W	350lm	100-240V 50/60 Hz	6500K/4000K/3000K
= 40W INCANDESCENT				

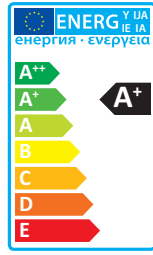

AVAILABLE COLORS			
COVER (MOULDED COLOURS)			DIFFUSER
BLACK (A)	GREY (L)	WHITE (W)	OPAL (Y)

LETI 100 SQUARE

CCT SET LED 3W GX53 LAMP INCLUDED 3C1.000.G1K

NEW VERSION CCT SETTABLE LAMP Master box: 48pcs

EXTRALETI 100 SQUARE

CCT SET LED 3W GX53 LAMP INCLUDED 3S1.000.G1K

NEW VERSION CCT SETTABLE LAMP Master box: 48pcs

LETI 100 SQUARE-GR

CCT SET LED 3W GX53 LAMP INCLUDED 3C2.000.G1K

NEW VERSION CCT SETTABLE LAMP Master box: 48pcs

EXTRALETI 100 SQUARE-GR

CCT SET LED 3W GX53 LAMP INCLUDED 3S2.000.G1K

NEW VERSION CCT SETTABLE LAMP Master box: 48pcs

LETI 100 SQUARE-EL

CCT SET LED 3W GX53 LAMP INCLUDED 3C3.000.G1K

NEW VERSION CCT SETTABLE LAMP Master box: 48pcs

EXTRALETI 100 SQUARE-EL

CCT SET LED 3W GX53 LAMP INCLUDED 3S3.000.G1K

NEW VERSION CCT SETTABLE LAMP Master box: 48pcs

LETI 100 SQUARE-ST

CCT SET LED 3W GX53 LAMP INCLUDED 3C4.000.G1K

NEW VERSION CCT SETTABLE LAMP Master box: 48pcs

EXTRALETI 100 SQUARE-ST

CCT SET LED 3W GX53 LAMP INCLUDED 3S4.000.G1K

NEW VERSION CCT SETTABLE LAMP Master box: 48pcs



BRICKLIGHT

LETI/EXTRALETI 200

LETI/EXTRALETI 200 LED VERSIONS				
LAMP	POWER	LUMINOUS FLUX	VOLTAGE RANGE	CCT SETTABLE
	3W	350lm	100-240V 50/60 Hz	6500K/4000K/3000K
= 40W INCANDESCENT				

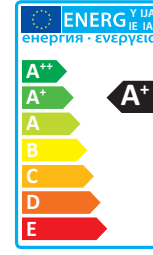

AVAILABLE COLORS			
COVER (MOULDED COLOURS)			DIFFUSER
BLACK (A)	GREY (L)	WHITE (W)	OPAL (Y)

LETI 200

CCT SET LED 3W GX53 LAMP INCLUDED 4C1.000.G1K

NEW VERSION CCT SETTABLE LAMP Master box: 36pcs

EXTRALETI 200

CCT SET LED 3W GX53 LAMP INCLUDED 4S1.000.G1K

NEW VERSION CCT SETTABLE LAMP Master box: 36pcs

LETI 200-GL

CCT SET LED 3W GX53 LAMP INCLUDED 4C2.000.G1K

NEW VERSION CCT SETTABLE LAMP Master box: 36pcs

EXTRALETI 200-GL

CCT SET LED 3W GX53 LAMP INCLUDED 4S2.000.G1K

NEW VERSION CCT SETTABLE LAMP Master box: 36pcs

LETI 200-RS

CCT SET LED 3W GX53 LAMP INCLUDED 4C3.000.G1K

NEW VERSION CCT SETTABLE LAMP Master box: 36pcs

EXTRALETI 200-RS

CCT SET LED 3W GX53 LAMP INCLUDED 4S3.000.G1K

NEW VERSION CCT SETTABLE LAMP Master box: 36pcs

LETI 200-HS

CCT SET LED 3W GX53 LAMP INCLUDED 4C4.000.G1K

NEW VERSION CCT SETTABLE LAMP Master box: 36pcs

EXTRALETI 200-HS

CCT SET LED 3W GX53 LAMP INCLUDED 4S4.000.G1K

NEW VERSION CCT SETTABLE LAMP Master box: 36pcs

LETI 200-VP

CCT SET LED 3W GX53 LAMP INCLUDED 4C5.000.G1K

NEW VERSION CCT SETTABLE LAMP Master box: 36pcs

EXTRALETI 200-VP

CCT SET LED 3W GX53 LAMP INCLUDED 4S5.000.G1K

NEW VERSION CCT SETTABLE LAMP Master box: 36pcs

4 NEWS
28 BOLLARD
46 UP&DOWN
54 FLOODLIGHT
64 IN-GROUND
68 BRICKLIGHT
74 BULKHEAD
92 POST
96 LAMPS

LETI 300/EXTRALETI 300

BRICKLIGHT



MADE IN ITALY



5S1.000

NEW SLIMMER BODY VERSION

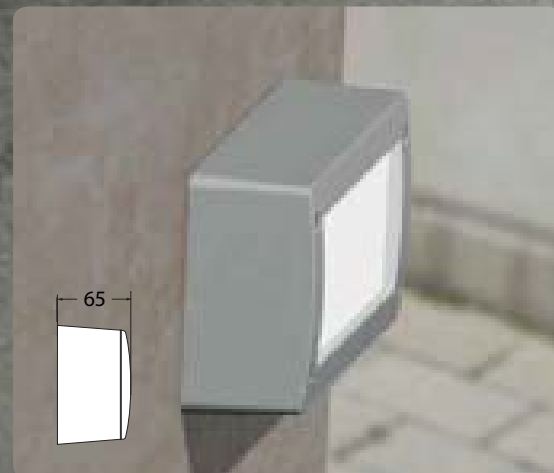

CCT SETTABLE **NEW**

3000 K 4000 K 6500 K

SDCM <6



BRICKLIGHT

LETI/EXTRALETI 300

LETI/EXTRALETI 300 LED VERSIONS				
LAMP	POWER	LUMINOUS FLUX	VOLTAGE RANGE	CCT SETTABLE
2x GX53	2x 3W 6W	700lm	100-240V 50/60 Hz	6500K/4000K/3000K 6500K/4000K/3000K 6500K/4000K/3000K
				40W INCANDESCENT

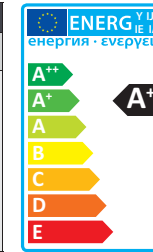

AVAILABLE COLORS			
COVER (MOULDED COLOURS)			DIFFUSER
BLACK (A)	GREY (L)	WHITE (W)	OPAL (Y)

LETI 300

CCT SET LED 3W GX53 LAMP INCLUDED

5C1.000.G2K
E27 5C1.000.E27

NEW VERSION CCT SETTABLE LAMP Master box: 24pcs

EXTRALETI 300

CCT SET LED 3W GX53 LAMP INCLUDED

5S1.000.G2K

NEW VERSION CCT SETTABLE LAMP Master box: 20pcs

LETI 300-GL

CCT SET LED 3W GX53 LAMP INCLUDED

5C2.000.G2K
E27 5C2.000.E27

NEW VERSION CCT SETTABLE LAMP Master box: 24pcs

EXTRALETI 300-GL

CCT SET LED 3W GX53 LAMP INCLUDED

5S2.000.G2K

NEW VERSION CCT SETTABLE LAMP Master box: 20pcs

LETI 300-RS

CCT SET LED 3W GX53 LAMP INCLUDED

5C3.000.G2K
E27 5C3.000.E27

NEW VERSION CCT SETTABLE LAMP Master box: 24pcs

EXTRALETI 300-RS

CCT SET LED 3W GX53 LAMP INCLUDED

5S3.000.G2K

NEW VERSION CCT SETTABLE LAMP Master box: 20pcs

LETI 300-HS

CCT SET LED 3W GX53 LAMP INCLUDED

5C4.000.G2K
E27 5C4.000.E27

NEW VERSION CCT SETTABLE LAMP Master box: 24pcs

EXTRALETI 300-HS

CCT SET LED 3W GX53 LAMP INCLUDED

5S4.000.G2K

NEW VERSION CCT SETTABLE LAMP Master box: 20pcs

LETI 300-VP

CCT SET LED 3W GX53 LAMP INCLUDED

5C5.000.G2K
E27 5C5.000.E27

Master box: 24pcs

NEW VERSION CCT SETTABLE LAMP

EXTRALETI 300-VP

CCT SET LED 3W GX53 LAMP INCLUDED

5S5.000.G2K

Master box: 20pcs

NEW VERSION CCT SETTABLE LAMP

4 NEWS
28 BOLLARD
46 UP&DOWN
54 FLOODLIGHT
64 IN-GROUND
68 BRICKLIGHT
74 BULKHEAD
92 POST
96 LAMPS

BERTINA BULKHEAD

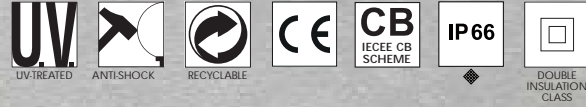

MADE IN ITALY



**NO SCREWS
AT SIGHT**

CCT SETTABLE **NEW**

3000 K 4000 K 6500 K

SDCM <6



BULKHEAD

BERTINA

BERTINA LED VERSIONS **NEW**

LAMP	POWER	LUMINOUS FLUX	VOLTAGE RANGE	CCT SETTABLE	INCANDESCENT EQUIVALENT
GX53	3W	350Lm	100-240V 50/60 Hz	6500K/4000K/3000K	40W
GX53	7W	800Lm	100-240V 50/60 Hz	6500K/4000K/3000K	75W
GX53	10W	1200Lm	100-240V 50/60 Hz	6500K/4000K/3000K	100W

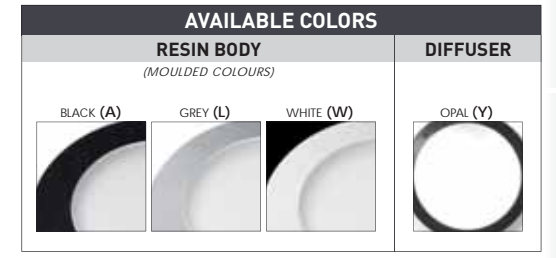
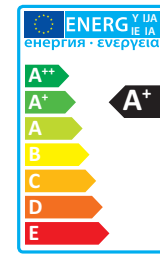

BERTINA

LED GX53 LAMP INCLUDED	CCT SET	Product Code
3W		1B1.000.G1K
7W		1B1.000.C1K
10W		1B1.000.D1K

NEW VERSION CCT SETTABLE LAMP

Master box: 45pcs

AVAILABLE VERSIONS SUPPLIED FULLY PRE-WIRED



4 NEWS
28 BOLLARD
46 UP&DOWN
54 FLOODLIGHT
64 IN-GROUND
68 BRICKLIGHT
74 BULKHEAD
92 POST
96 LAMPS

BERTA

BULKHEAD



MADE IN ITALY

1B2.000



NO SCREWS AT SIGHT



BULKHEAD

BERTA

BERTA LED VERSIONS					
LAMP	POWER	LUMINOUS FLUX	VOLTAGE RANGE	COLOUR TEMPERATURE	
	7W	600Lm	100-240V 50/60 Hz	4000K 3000K	60W INCANDESCENT
	11W	1300Lm	100-240V 50/60 Hz	4000K 3000K	100W INCANDESCENT
	18W	2000Lm	100-240V 50/60 Hz	4000K 3000K	150W INCANDESCENT

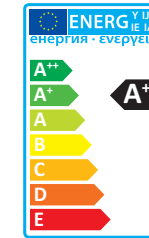

AVAILABLE COLORS			
RESIN BODY (MOULDED COLOURS)			DIFFUSER
BLACK (A)	GREY (L)	WHITE (W)	OPAL (Y)

BERTA

E27		1B2.000.P27
E27 WITH SENSOR		1B2.000.PS7
7W LED	4000K	1B2.000.A1L
LED	3000K	1B2.000.A1R
11W LED	4000K	1B2.000.B1L
LED	3000K	1B2.000.B1R
18W LED	4000K	1B2.000.E1L
LED	3000K	1B2.000.E1R

Master box: 16pcs

AVAILABLE VERSIONS SUPPLIED FULLY PRE-WIRED

E27

E27 +SENSOR

GX53 LED

4 NEWS
28 BOLLARD
46 UP&DOWN
54 FLOODLIGHT
64 IN-GROUND
68 BRICKLIGHT
74 BULKHEAD
92 POST
96 LAMPS

UMBERTA

BULKHEAD



1B3.000



**NO SCREWS
AT SIGHT**



BULKHEAD

UMBERTA

UMBERTA LED VERSIONS					
LAMP	POWER	LUMINOUS FLUX	VOLTAGE RANGE	COLOUR TEMPERATURE	
	7W	600Lm	100-240V 50/60 Hz	4000K 3000K	≈ 60W INCANDESCENT
	11W	1300Lm	100-240V 50/60 Hz	4000K 3000K	≈ 100W INCANDESCENT
	18W	2000Lm	100-240V 50/60 Hz	4000K 3000K	≈ 150W INCANDESCENT

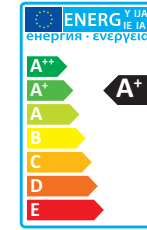

AVAILABLE COLORS			
RESIN BODY (MOULDED COLOURS)			DIFFUSER
BLACK (A)	GREY (L)	WHITE (W)	OPAL (Y)

UMBERTA

E27		1B3.000.E27
2x E27		1B3.000.E28
7W LED	4000K	1B3.000.A1L
11W LED	3000K	1B3.000.A1R
11W LED	4000K	1B3.000.B1L
11W LED	3000K	1B3.000.B1R
18W LED	4000K	1B3.000.E1L
18W LED	3000K	1B3.000.E1R

LED
GX53
LAMP
INCLUDED

Master box: 12pcs



4 NEWS
28 BOLLARD
46 UP&DOWN
54 FLOODLIGHT
64 IN-GROUND
68 BRICKLIGHT
74 BULKHEAD
92 POST
96 LAMPS

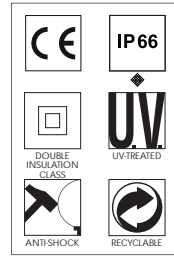
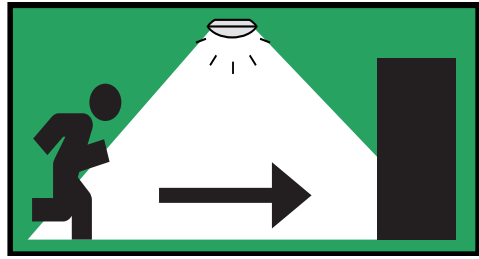

UMBERTA EMERGENCY - LED VERSIONS					
EMERGENCY KIT	MODE	POWER	LUMINOUS FLUX	VOLTAGE RANGE	COLOUR TEMPERATURE
	NORMAL	15W	2000Lm	220-240V 50/60 Hz	4000K
	EMERGENCY (min 3 hours)	2,4W	250Lm	220-240V 50/60 Hz	4000K

UMBERTA LED MAINTAINED EMERGENCY

LED 4000K 1B3.000.EM1

PRODUCT TYPE	Wall and Ceiling bulkhead with Emergency kit
OPERATING VOLTAGE	220~240 vAC
LUMINOUS FLUX & POWER	2000 lumen (Normal mode), 15W 250 lumen (Emergency mode), 2.4W
LED TYPE	Edison SMD 2835, 4000 K
CRI	>80Ra
PF (POWER FACTOR)	>0.95
BEAM ANGLE	120°
OPERATING TEMPERATURE	0~50°C
BATTERY	Ni-MH, BK370Ah3.6V, Panasonic (3.5Ah, 3.6V)
BATTERY OPERATING TIME	min 3 hours (250 lumen)
BATTERY CHARGING TIME	24 hours
Drivers Standards	EN 61347-1, EN 61347-2-7, EN 61347-2-13, EN 62384, EN 60598-2-22, EN 55015, EN61547, EN 61000-3-2, EN 61000-3-3
Battery Standards	EN 5501-1, EN 61000, EN 55014-2

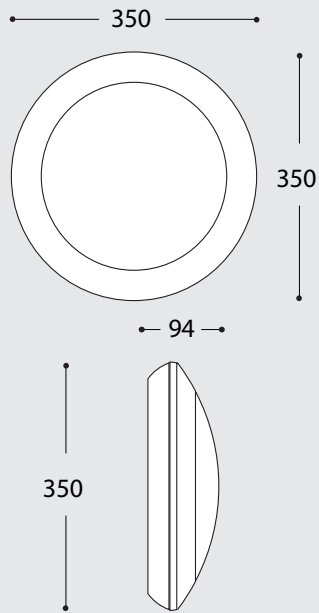

HOW IT WORKS

In case of blackout, the emergency kit turns on. The Bulkhead switches from Normal mode to Emergency mode and keeps on working.



Provided with built-in test button to check battery status.



Green Led: identifies the emergency light and shows that the system is operating correctly.

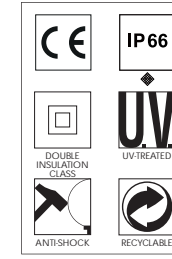
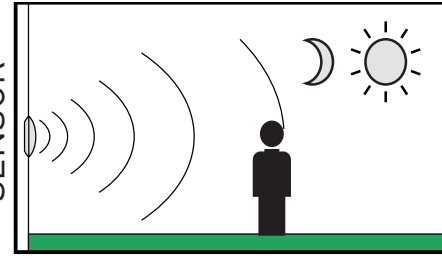

BERTA LED VERSIONS					
LAMP	POWER	LUMINOUS FLUX	VOLTAGE RANGE	COLOUR TEMPERATURE	
	7W	600Lm	100-240V 50/60 Hz	4000K 3000K	= 60W INCANDESCENT
	11W	1300Lm	100-240V 50/60 Hz	4000K 3000K	= 100W INCANDESCENT
	18W	2000Lm	100-240V 50/60 Hz	4000K 3000K	= 150W INCANDESCENT

UMBERTA MOTION & DAYLIGHT SENSOR

E27 WITH SENSOR)))		1B3.000.ES7
2x E27 WITH SENSOR)))		1B3.000.ES8
7W LED GX53 WITH SENSOR)))	4000K 3000K	1B3.000.ASL 1B3.000.ASR
11W LED GX53 WITH SENSOR)))	4000K 3000K	1B3.000.BSL 1B3.000.BSR
18W LED GX53 WITH SENSOR)))	4000K 3000K	1B3.000.ESL 1B3.000.ESR

Product Type	Wall and Ceiling bulkhead with Motion&Daylight sensor
Sensor operating voltage	220~240 vAC (120v version available on demand)
Version	GX53 LED, E27, 2xE27
Sensor Operating Temperature	-10° +60°C
Detection angle	30° - 150°
Fields of detection	1 - up to 5 mt (adjustable)

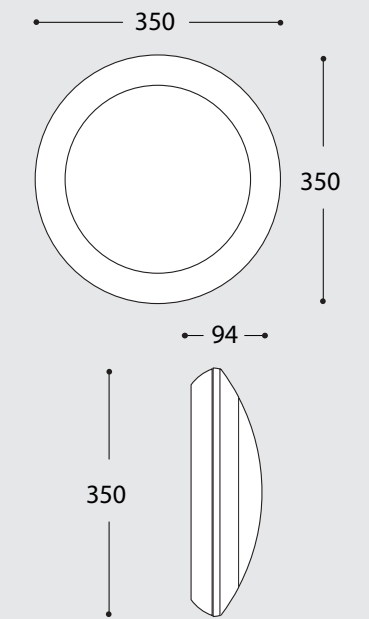

GELMI BULKHEAD



1G3.000



BULKHEAD

GELMI RANGE

LED BULKHEAD GX53					
LAMP	POWER	LUMINOUS FLUX	VOLTAGE RANGE	COLOUR TEMPERATURE	
	7W	600Lm	100-240V 50/60 Hz	4000K	= 60W INCANDESCENT
	11W	1300Lm	100-240V 50/60 Hz	4000K	= 100W INCANDESCENT
	18W	2000Lm	100-240V 50/60 Hz	4000K	= 150W INCANDESCENT

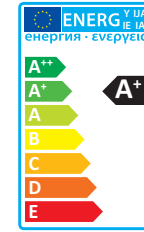

AVAILABLE COLORS			
RESIN BODY (MOULDED COLOURS)			DIFFUSER
BLACK (A)	GREY (L)	WHITE (W)	OPAL (Y)

GELMI

LED GX53 LAMP INCLUDED

Model	Power	Color Temp	Product Code
E27			1G3.000.E27
GX53 LED 7W	4000K		1G3.000.A1L
	3000K		1G3.000.A1R
GX53 LED 11W	4000K		1G3.000.B1L
	3000K		1G3.000.B1R
GX53 LED 18W	4000K		1G3.000.E1L
	3000K		1G3.000.E1R

Master box: 16pcs

GELMI-EL

LED GX53 LAMP INCLUDED

Model	Power	Color Temp	Product Code
E27			2G3.000.E27
GX53 LED 7W	4000K		2G3.000.A1L
	3000K		2G3.000.A1R
GX53 LED 11W	4000K		2G3.000.B1L
	3000K		2G3.000.B1R
GX53 LED 18W	4000K		2G3.000.E1L
	3000K		2G3.000.E1R

Master box: 16pcs

GELMI-GR

LED GX53 LAMP INCLUDED

Model	Power	Color Temp	Product Code
E27			3G3.000.E27
GX53 LED 7W	4000K		3G3.000.A1L
	3000K		3G3.000.A1R
GX53 LED 11W	4000K		3G3.000.B1L
	3000K		3G3.000.B1R
GX53 LED 18W	4000K		3G3.000.E1L
	3000K		3G3.000.E1R

Master box: 16pcs

4 NEWS
28 BOLLARD
46 UP&DOWN
54 FLOODLIGHT
64 IN-GROUND
68 BRICKLIGHT
74 BULKHEAD
92 POST
96 LAMPS

DANZI BULKHEAD



1D3.000



SUPPLIED FULLY PRE-WIRED

GX53 LED

E27

E27 + SENSOR

WITH SENSOR)))
220-240V
(.ES7)



BULKHEAD

DANZI RANGE

LED BULKHEAD GX53					
LAMP	POWER	LUMINOUS FLUX	VOLTAGE RANGE	COLOUR TEMPERATURE	
	7W	600Lm	100-240V 50/60 Hz	4000K 3000K	= 60W INCANDESCENT
	11W	1300Lm	100-240V 50/60 Hz	4000K 3000K	= 100W INCANDESCENT
	18W	2000Lm	100-240V 50/60 Hz	4000K 3000K	= 150W INCANDESCENT

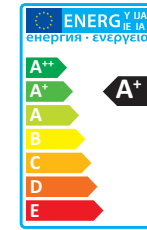

AVAILABLE COLORS			
RESIN BODY (MOULDED COLOURS)			DIFFUSER
BLACK (A)	GREY (L)	WHITE (W)	OPAL (Y)

DANZI

LED GX53 LAMP INCLUDED

E27		1D3.000.E27
GX53 LED 7W	4000K	1D3.000.A1L
	3000K	1D3.000.A1R
GX53 LED 11W	4000K	1D3.000.B1L
	3000K	1D3.000.B1R
GX53 LED 18W	4000K	1D3.000.E1L
	3000K	1D3.000.E1R

Master box: 16pcs

DANZI-VE

LED GX53 LAMP INCLUDED

E27		2D3.000.E27
GX53 LED 7W	4000K	2D3.000.A1L
	3000K	2D3.000.A1R
GX53 LED 11W	4000K	2D3.000.B1L
	3000K	2D3.000.B1R
GX53 LED 18W	4000K	2D3.000.E1L
	3000K	2D3.000.E1R

Master box: 16pcs

DANZI-GR

LED GX53 LAMP INCLUDED

E27		3D3.000.E27
GX53 LED 7W	4000K	3D3.000.A1L
	3000K	3D3.000.A1R
GX53 LED 11W	4000K	3D3.000.B1L
	3000K	3D3.000.B1R
GX53 LED 18W	4000K	3D3.000.E1L
	3000K	3D3.000.E1R

Master box: 16pcs

4 NEWS
28 BOLLARD
46 UP&DOWN
54 FLOODLIGHT
64 IN-GROUND
68 BRICKLIGHT
74 BULKHEAD
92 POST
96 LAMPS



MADE IN ITALY



1U3.000

SUPPLIED FULLY PRE-WIRED

GX53 LED	E27	E27 + SENSOR
----------	-----	--------------

WITH SENSOR)))
220-240V
(.ES7)

BACKLIT COLOURS AVAILABLE

*To order the backlit version of our bulkhead, the following suffixes have to be added at the end of the code.

CLEAR .CL1	PINK .PK1	BLUE .BU1	GREEN .GN1	ORANGE .OR1
---------------	--------------	--------------	---------------	----------------

LED BULKHEAD GX53

LAMP	POWER	LUMINOUS FLUX	VOLTAGE RANGE	COLOUR TEMPERATURE	
	7W	600Lm	100-240V 50/60 Hz	4000K	= 60W INCANDESCENT
	11W	1300Lm	100-240V 50/60 Hz	4000K	= 100W INCANDESCENT
	18W	2000Lm	100-240V 50/60 Hz	4000K	= 150W INCANDESCENT

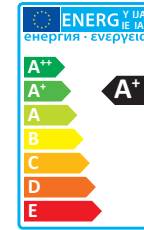

AVAILABLE COLORS

RESIN BODY (MOULDED COLOURS)			DIFFUSER
BLACK (A)	GREY (L)	WHITE (W)	OPAL (Y)

STUCCHI

		LED GX53 LAMP INCLUDED	<table border="1"> <tr> <td>E27</td> <td></td> <td>1U3.000.E27</td> </tr> <tr> <td rowspan="2">GX53 LED 7W</td> <td>4000K</td> <td>1U3.000.A1L</td> </tr> <tr> <td>3000K</td> <td>1U3.000.A1R</td> </tr> <tr> <td rowspan="2">GX53 LED 11W</td> <td>4000K</td> <td>1U3.000.B1L</td> </tr> <tr> <td>3000K</td> <td>1U3.000.B1R</td> </tr> <tr> <td rowspan="2">GX53 LED 18W</td> <td>4000K</td> <td>1U3.000.E1L</td> </tr> <tr> <td>3000K</td> <td>1U3.000.E1R</td> </tr> </table>	E27		1U3.000.E27	GX53 LED 7W	4000K	1U3.000.A1L	3000K	1U3.000.A1R	GX53 LED 11W	4000K	1U3.000.B1L	3000K	1U3.000.B1R	GX53 LED 18W	4000K	1U3.000.E1L	3000K	1U3.000.E1R
E27		1U3.000.E27																			
GX53 LED 7W	4000K	1U3.000.A1L																			
	3000K	1U3.000.A1R																			
GX53 LED 11W	4000K	1U3.000.B1L																			
	3000K	1U3.000.B1R																			
GX53 LED 18W	4000K	1U3.000.E1L																			
	3000K	1U3.000.E1R																			

BACKLIT COLOURS VERSION

*To order the backlit version of our bulkhead, the following suffixes have to be added at the end of the code.

CLEAR .CL1	PINK .PK1	BLUE .BU1	GREEN .GN1	ORANGE .OR1
---------------	--------------	--------------	---------------	----------------

Master box: 16pcs

CECCHI

		LED GX53 LAMP INCLUDED	<table border="1"> <tr> <td>E27</td> <td></td> <td>1H3.000.E27</td> </tr> <tr> <td rowspan="2">GX53 LED 7W</td> <td>4000K</td> <td>1H3.000.A1L</td> </tr> <tr> <td>3000K</td> <td>1H3.000.A1R</td> </tr> <tr> <td rowspan="2">GX53 LED 11W</td> <td>4000K</td> <td>1H3.000.B1L</td> </tr> <tr> <td>3000K</td> <td>1H3.000.B1R</td> </tr> <tr> <td rowspan="2">GX53 LED 18W</td> <td>4000K</td> <td>1H3.000.E1L</td> </tr> <tr> <td>3000K</td> <td>1H3.000.E1R</td> </tr> </table>	E27		1H3.000.E27	GX53 LED 7W	4000K	1H3.000.A1L	3000K	1H3.000.A1R	GX53 LED 11W	4000K	1H3.000.B1L	3000K	1H3.000.B1R	GX53 LED 18W	4000K	1H3.000.E1L	3000K	1H3.000.E1R
E27		1H3.000.E27																			
GX53 LED 7W	4000K	1H3.000.A1L																			
	3000K	1H3.000.A1R																			
GX53 LED 11W	4000K	1H3.000.B1L																			
	3000K	1H3.000.B1R																			
GX53 LED 18W	4000K	1H3.000.E1L																			
	3000K	1H3.000.E1R																			

BACKLIT COLOURS VERSION

*To order the backlit version of our bulkhead, the following suffixes have to be added at the end of the code.

CLEAR .CL1	PINK .PK1	BLUE .BU1	GREEN .GN1	ORANGE .OR1
---------------	--------------	--------------	---------------	----------------

Master box: 16pcs

RITA

		LED GX53 LAMP INCLUDED	<table border="1"> <tr> <td>E27</td> <td></td> <td>1T3.000.E27</td> </tr> <tr> <td rowspan="2">GX53 LED 7W</td> <td>4000K</td> <td>1T3.000.A1L</td> </tr> <tr> <td>3000K</td> <td>1T3.000.A1R</td> </tr> <tr> <td rowspan="2">GX53 LED 11W</td> <td>4000K</td> <td>1T3.000.B1L</td> </tr> <tr> <td>3000K</td> <td>1T3.000.B1R</td> </tr> <tr> <td rowspan="2">GX53 LED 18W</td> <td>4000K</td> <td>1T3.000.E1L</td> </tr> <tr> <td>3000K</td> <td>1T3.000.E1R</td> </tr> </table>	E27		1T3.000.E27	GX53 LED 7W	4000K	1T3.000.A1L	3000K	1T3.000.A1R	GX53 LED 11W	4000K	1T3.000.B1L	3000K	1T3.000.B1R	GX53 LED 18W	4000K	1T3.000.E1L	3000K	1T3.000.E1R
E27		1T3.000.E27																			
GX53 LED 7W	4000K	1T3.000.A1L																			
	3000K	1T3.000.A1R																			
GX53 LED 11W	4000K	1T3.000.B1L																			
	3000K	1T3.000.B1R																			
GX53 LED 18W	4000K	1T3.000.E1L																			
	3000K	1T3.000.E1R																			

MOULDED COLOURS
BLACK(A) WHITE(W)

PAINTED COLOURS
*To order the painted colour version of RITA, the following suffixes have to be added at the end of the code.
ANTIQUÉ GREEN(V) ANTIQUÉ BRONZE(B)

Master box: 12pcs

4 NEWS
28 BOLLARD
46 UP&DOWN
54 FLOODLIGHT
64 IN-GROUND
68 BRICKLIGHT
74 BULKHEAD
92 POST
96 LAMPS

LUCIA BULKHEAD



MADE IN ITALY



1R3.000

BACKLIT COLOURS AVAILABLE

*To order the backlit version of our bulkhead, the following suffixes have to be added at the end of the code.

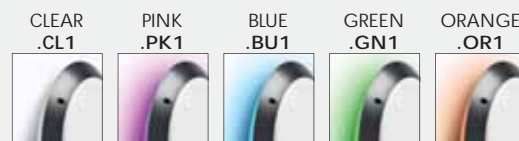

BRACKET VERSION AVAILABLE

2R3.602



SUPPLIED FULLY PRE-WIRED



WITH SENSOR)))
220-240V
(.ES7)



BULKHEAD

LUCIA RANGE

LED BULKHEAD GX53					
LAMP	POWER	LUMINOUS FLUX	VOLTAGE RANGE	COLOUR TEMPERATURE	
	7W	600Lm	100-240V 50/60 Hz	4000K 3000K	60W INCANDESCENT
	11W	1300Lm	100-240V 50/60 Hz	4000K 3000K	100W INCANDESCENT
	18W	2000Lm	100-240V 50/60 Hz	4000K 3000K	150W INCANDESCENT



AVAILABLE COLORS			
RESIN BODY (MOULDED COLOURS)			DIFFUSER
BLACK (A)	GREY (L)	WHITE (W)	OPAL (Y)

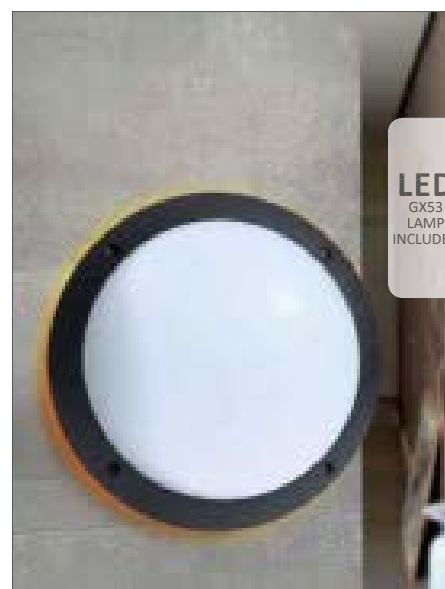

LED
GX53
LAMP
INCLUDED

LUCIA	
E27	1R3.000.E27
GX53 4000K	1R3.000.A1L
LED 7W 3000K	1R3.000.A1R
GX53 4000K	1R3.000.B1L
LED 11W 3000K	1R3.000.B1R
GX53 4000K	1R3.000.E1L
LED 18W 3000K	1R3.000.E1R

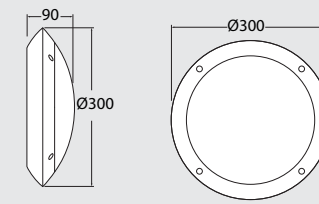

Master box: 16pcs

REMI/LUCIA	
E27	1R3.602.E27
GX53 4000K	1R3.602.A1L
LED 7W 3000K	1R3.602.A1R
GX53 4000K	1R3.602.B1L
LED 11W 3000K	1R3.602.B1R
GX53 4000K	1R3.602.E1L
LED 18W 3000K	1R3.602.E1R

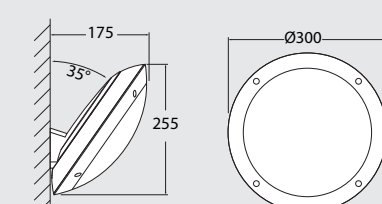

Master box: 16pcs



LED
GX53
LAMP
INCLUDED

LUCIA-EL	
E27	2R3.000.E27
GX53 4000K	2R3.000.A1L
LED 7W 3000K	2R3.000.A1R
GX53 4000K	2R3.000.B1L
LED 11W 3000K	2R3.000.B1R
GX53 4000K	2R3.000.E1L
LED 18W 3000K	2R3.000.E1R

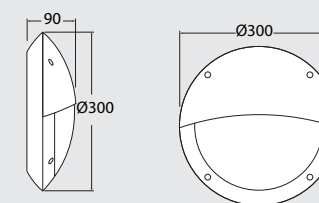

Master box: 16pcs

REMI/LUCIA-EL	
E27	2R3.602.E27
GX53 4000K	2R3.602.A1L
LED 7W 3000K	2R3.602.A1R
GX53 4000K	2R3.602.B1L
LED 11W 3000K	2R3.602.B1R
GX53 4000K	2R3.602.E1L
LED 18W 3000K	2R3.602.E1R

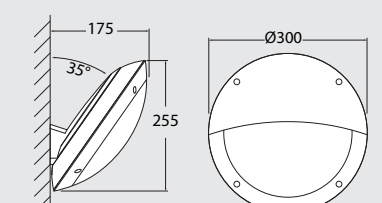

Master box: 16pcs



LED
GX53
LAMP
INCLUDED

LUCIA-GD	
E27	3R3.000.E27
GX53 4000K	3R3.000.A1L
LED 7W 3000K	3R3.000.A1R
GX53 4000K	3R3.000.B1L
LED 11W 3000K	3R3.000.B1R
GX53 4000K	3R3.000.E1L
LED 18W 3000K	3R3.000.E1R

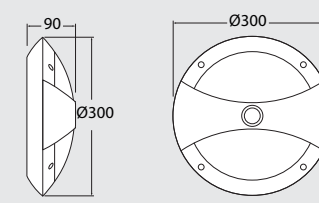

Master box: 16pcs

REMI/LUCIA-GD	
E27	3R3.602.E27
GX53 4000K	3R3.602.A1L
LED 7W 3000K	3R3.602.A1R
GX53 4000K	3R3.602.B1L
LED 11W 3000K	3R3.602.B1R
GX53 4000K	3R3.602.E1L
LED 18W 3000K	3R3.602.E1R

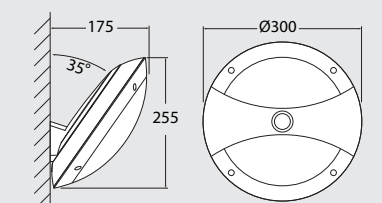

Master box: 16pcs

MADE IN ITALY

(12 Master Box per pallet)

4 NEWS
28 BOLLARD
46 UP&DOWN
54 FLOODLIGHT
64 IN-GROUND
68 BRICKLIGHT
74 BULKHEAD
92 POST
96 LAMPS

MADDI BULKHEAD



MADE IN ITALY



1V3.000

BACKLIT COLOURS AVAILABLE

*To order the backlit version of our bulkhead, the following suffixes have to be added at the end of the code.

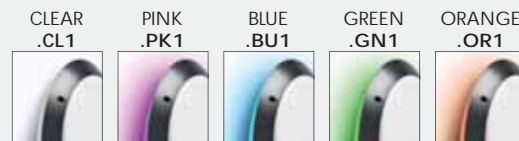

BRACKET VERSION AVAILABLE

1V3.602



SUPPLIED FULLY PRE-WIRED

GX53 LED E27 E27 + SENSOR



WITH SENSOR)))
220-240V
(.ES7)



BULKHEAD

MADDI RANGE

LED BULKHEAD GX53					
LAMP	POWER	LUMINOUS FLUX	VOLTAGE RANGE	COLOUR TEMPERATURE	
	7W	600Lm	100-240V 50/60 Hz	4000K	60W INCANDESCENT
	11W	1300Lm	100-240V 50/60 Hz	4000K	100W INCANDESCENT
	18W	2000Lm	100-240V 50/60 Hz	4000K	150W INCANDESCENT

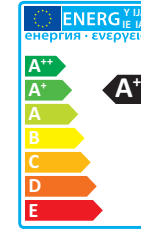

AVAILABLE COLORS			
RESIN BODY (MOULDED COLOURS)			DIFFUSER
BLACK (A)	GREY (L)	WHITE (W)	OPAL (Y)



LED GX53 LAMP INCLUDED

MADDI	
E27	1V3.000.E27
GX53 4000K	1V3.000.A1L
LED 7W 3000K	1V3.000.A1R
GX53 4000K	1V3.000.B1L
LED 11W 3000K	1V3.000.B1R
GX53 4000K	1V3.000.E1L
LED 18W 3000K	1V3.000.E1R

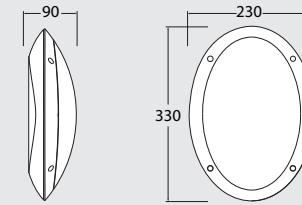

Master box: 16pcs

REMI/MADDI	
E27	1V3.602.E27
GX53 4000K	1V3.602.A1L
LED 7W 3000K	1V3.602.A1R
GX53 4000K	1V3.602.B1L
LED 11W 3000K	1V3.602.B1R
GX53 4000K	1V3.602.E1L
LED 18W 3000K	1V3.602.E1R

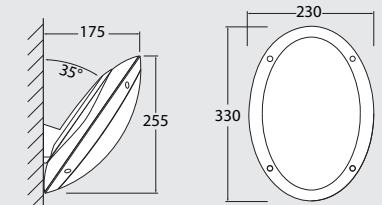

Master box: 16pcs



LED GX53 LAMP INCLUDED

MADDI-VE	
E27	2V3.000.E27
GX53 4000K	2V3.000.A1L
LED 7W 3000K	2V3.000.A1R
GX53 4000K	2V3.000.B1L
LED 11W 3000K	2V3.000.B1R
GX53 4000K	2V3.000.E1L
LED 18W 3000K	2V3.000.E1R

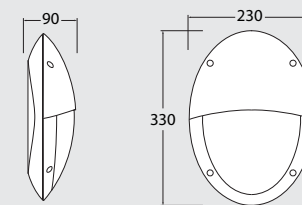

Master box: 16pcs

REMI/MADDI-VE	
E27	2V3.602.E27
GX53 4000K	2V3.602.A1L
LED 7W 3000K	2V3.602.A1R
GX53 4000K	2V3.602.B1L
LED 11W 3000K	2V3.602.B1R
GX53 4000K	2V3.602.E1L
LED 18W 3000K	2V3.602.E1R

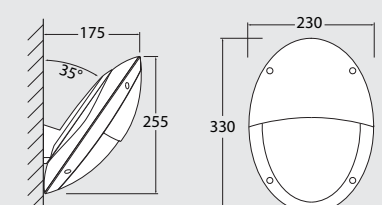

Master box: 16pcs



LED GX53 LAMP INCLUDED

MADDI-HL	
E27	3V3.000.E27
GX53 4000K	3V3.000.A1L
LED 7W 3000K	3V3.000.A1R
GX53 4000K	3V3.000.B1L
LED 11W 3000K	3V3.000.B1R
GX53 4000K	3V3.000.E1L
LED 18W 3000K	3V3.000.E1R

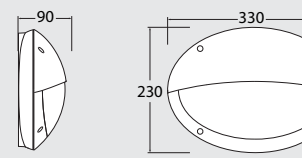

Master box: 16pcs

REMI/MADDI-HL	
E27	3V3.602.E27
GX53 4000K	3V3.602.A1L
LED 7W 3000K	3V3.602.A1R
GX53 4000K	3V3.602.B1L
LED 11W 3000K	3V3.602.B1R
GX53 4000K	3V3.602.E1L
LED 18W 3000K	3V3.602.E1R

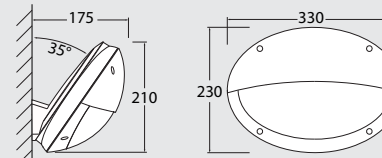

Master box: 16pcs

MADE IN ITALY

(12 Master Box per pallet)

4 NEWS
28 BOLLARD
46 UP&DOWN
54 FLOODLIGHT
64 IN-GROUND
68 BRICKLIGHT
74 BULKHEAD
92 POST
96 LAMPS

GIORGIO / ROSA

POST



MADE IN ITALY



AVAILABLE COLORS			AVAILABLE VERSIONS		
RESIN BODY (MOULDED COLOURS)			DIFFUSER		
BLACK (A)	GREY (L)	WHITE (W)	OPAL (Y)		
GX53 LED		4x GX53		2x E27	
LED GX53		LED GX53		LED GX53	



POST

EKTOR / GIORGIO - ROSA

GIORGIO LED VERSIONS					
LAMP	POWER	LUMINOUS FLUX	VOLTAGE RANGE	COLOUR TEMPERATURE	
	11W	1300Lm	100-240V 50/60 Hz	4000K 3000K	100W INCANDESCENT
	18W	2000Lm	100-240V 50/60 Hz	4000K 3000K	150W INCANDESCENT
4x	4x7W 28W	3200Lm	100-240V 50/60 Hz	6500K/4000K/3000K	70W HQI-SON
	4x10W 40W	4800Lm	100-240V 50/60 Hz	6500K/4000K/3000K	100W HQI-SON

ROSA LED VERSIONS					
LAMP	POWER	LUMINOUS FLUX	VOLTAGE RANGE	COLOUR TEMPERATURE	
	2x11W 22W	2600Lm	100-240V 50/60 Hz	4000K 3000K	2x100W INCANDESCENT
	2x18W 36W	4000Lm	100-240V 50/60 Hz	4000K 3000K	2x150W INCANDESCENT
	2x28W 56W	6400Lm	100-240V 50/60 Hz	6500K/4000K/3000K	2x70W HQI-SON
	2x40W 80W	9600Lm	100-240V 50/60 Hz	6500K/4000K/3000K	2x100W HQI-SON

EKTOR 2500 /GIORGIO		
E27	4P2.361.G10.E28	
11W	4000K	4P1.361.G10.B1L
	3000K	4P1.361.G10.B1R
18W	4000K	4P1.361.G10.E1L
	3000K	4P1.361.G10.E1R
4x7W 28W	CCT SET	4P2.361.G10.C4K
4x10W 40W	CCT SET	4P2.361.G10.D4K

EKTOR 2500 /ROSA		
2x E27	4P2.361.G20.E28	
2x 11W	4000K	4P1.361.G20.B1L
	3000K	4P1.361.G20.B1R
2x 18W	4000K	4P1.361.G20.E1L
	3000K	4P1.361.G20.E1R
2x 28W	CCT SET	4P2.361.G20.C4K
2x 40W	CCT SET	4P2.361.G20.D4K

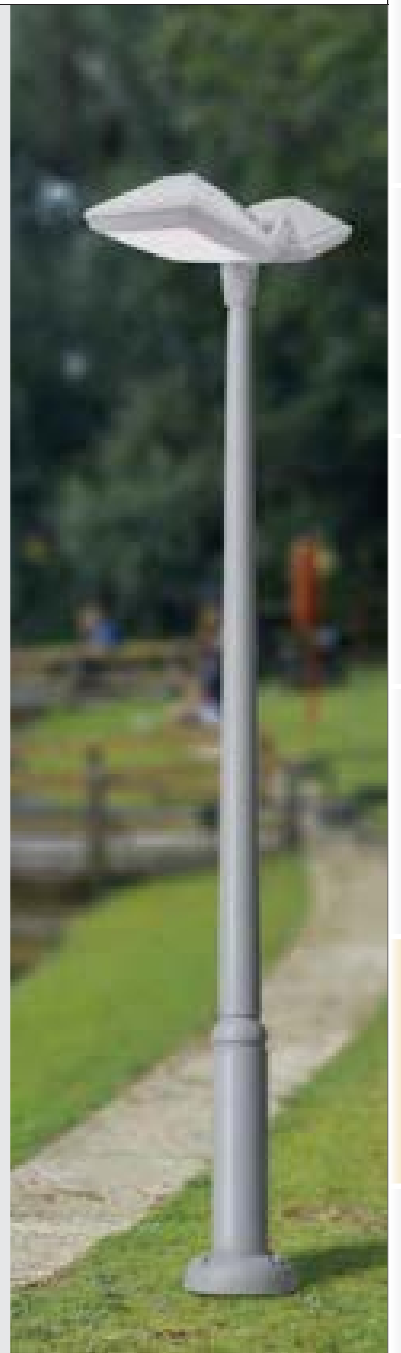
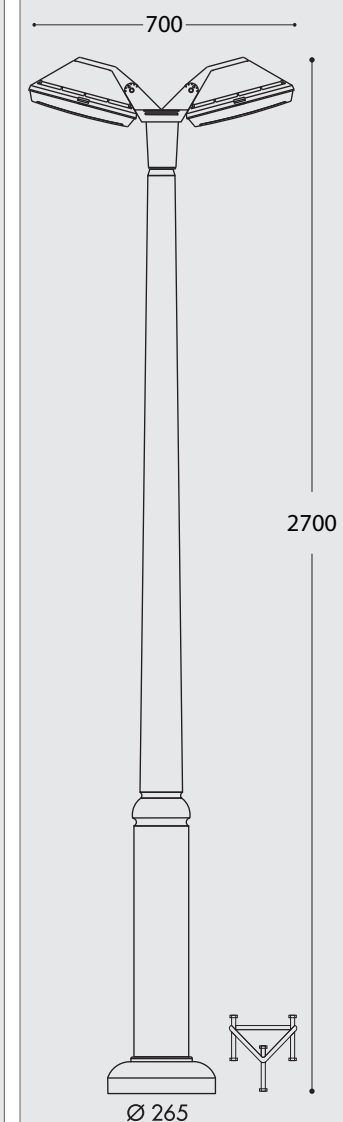
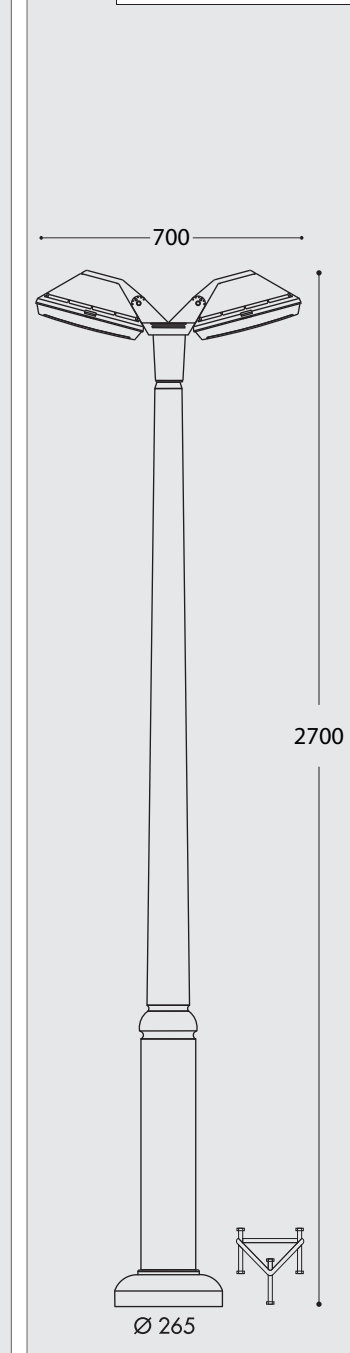
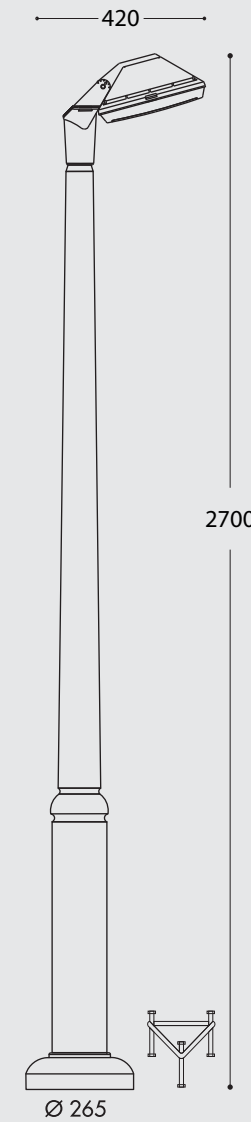
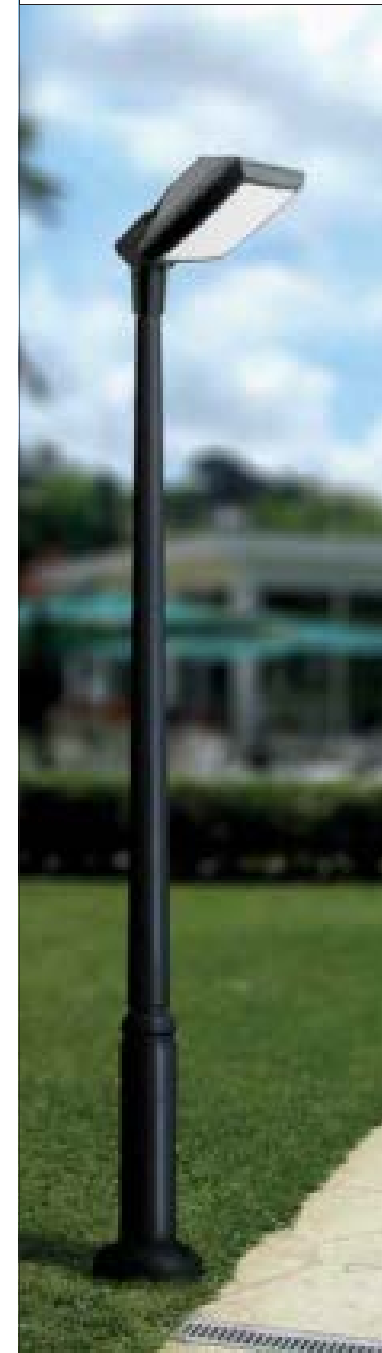

MADE IN ITALY

4 NEWS
28 BOLLARD
46 UP&DOWN
54 FLOODLIGHT
64 IN-GROUND
68 BRICKLIGHT
74 BULKHEAD
92 POST
96 LAMPS

BEPPE 400/VIVI 400

POST



MADE IN ITALY



NEW HIGH POWER LED

INDOOR & OUTDOOR USE

+80°C
-30°C 90% HUMIDITY

VOLTAGE SURGE RESISTANT

30W (3500 lm)
50W (5300 lm)

More details at page 103



POST

EKTOR / BEPPE-VIVI 400

BEPPE-VIVI 400 HIGH POWER LED					
LAMP	POWER	LUMINOUS FLUX	VOLTAGE RANGE	COLOUR TEMPERATURE	
HIGH POWER LED E27	30W	3500Lm	100-240V 50/60 Hz	4000K 3000K	= 50W HQI-SON
HIGH POWER LED E27	50W	5300Lm	100-240V 50/60 Hz	4000K 3000K	= 70W HQI-SON

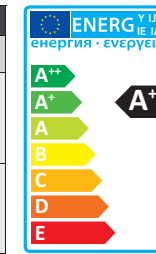

AVAILABLE COLORS				
RESIN BODY (MOULDED COLOURS)			DIFFUSER	
BLACK (A)	GREY (L)	WHITE (W)	CLEAR (X)	OPAL (Y)

EKTOR 2500 / BEPPE400			
30W LED	4000K	P50.361.Q1L	
	3000K	P50.361.Q1R	
50W LED	4000K	P50.361.H1L	
	3000K	P50.361.H1R	

EKTOR 2500 MIDIPILAR / VIVI400 1L			
30W LED	4000K	V50.361.A10.Q1L	
	3000K	V50.361.A10.Q1R	
50W LED	4000K	V50.361.A10.H1L	
	3000K	V50.361.A10.H1R	

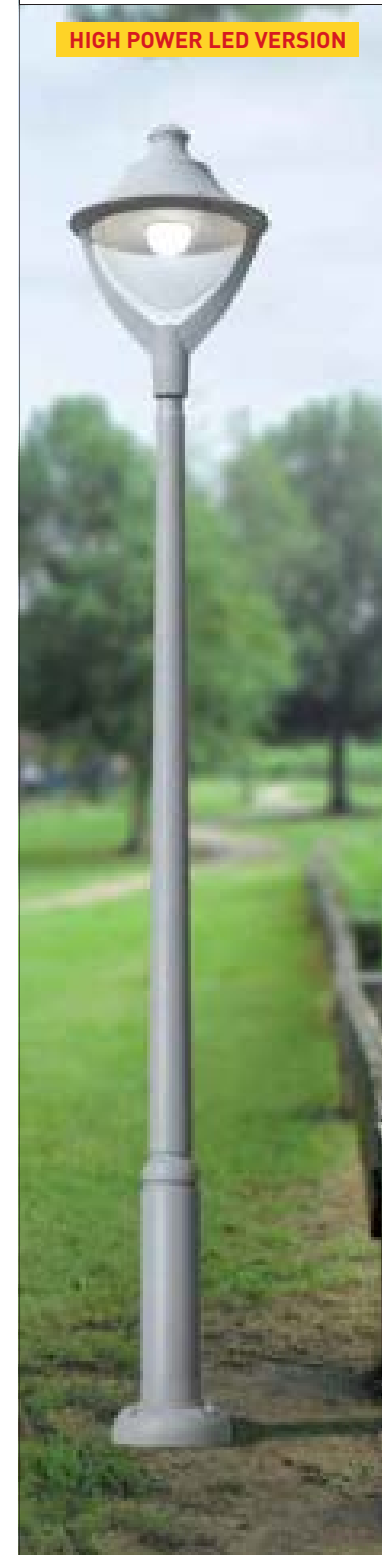

480

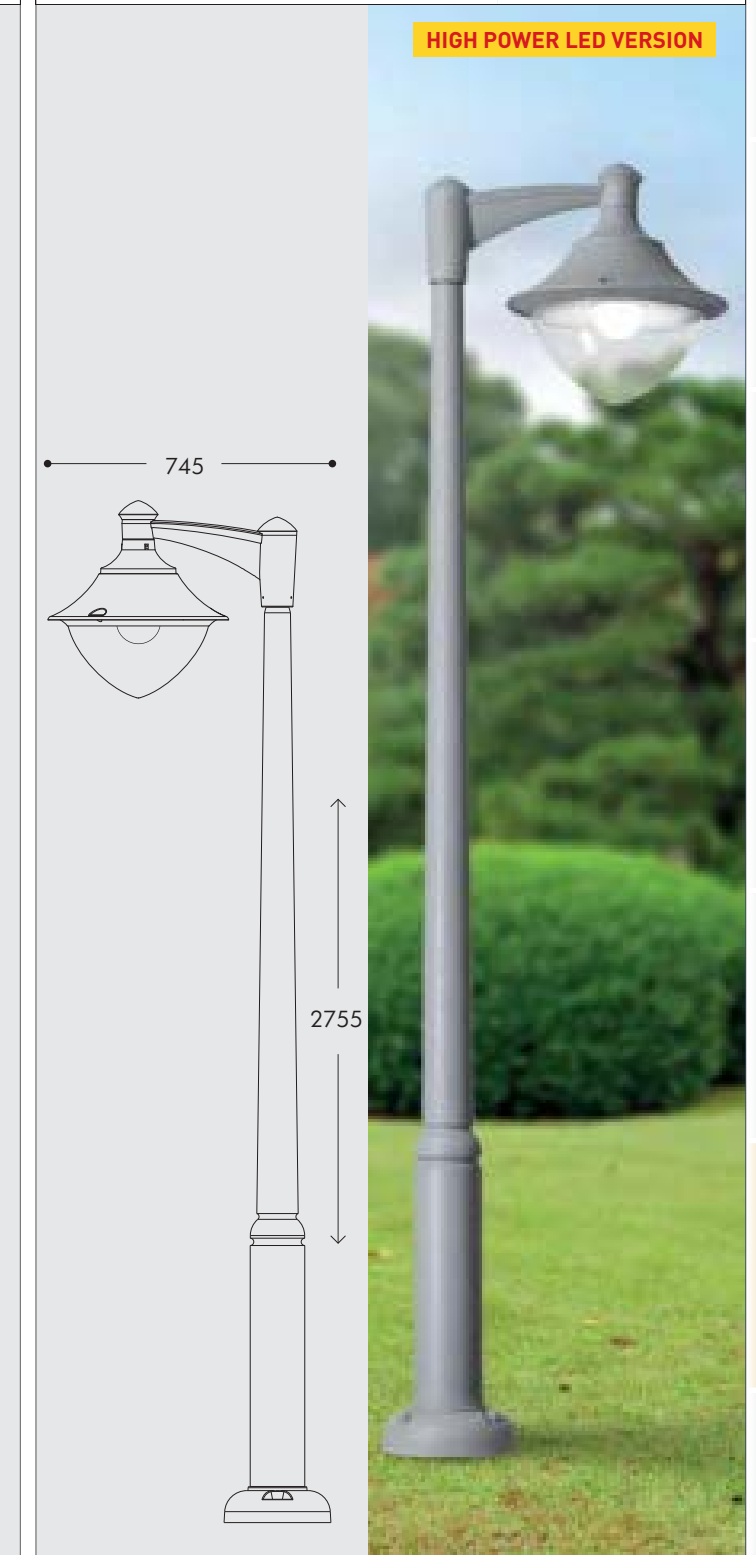
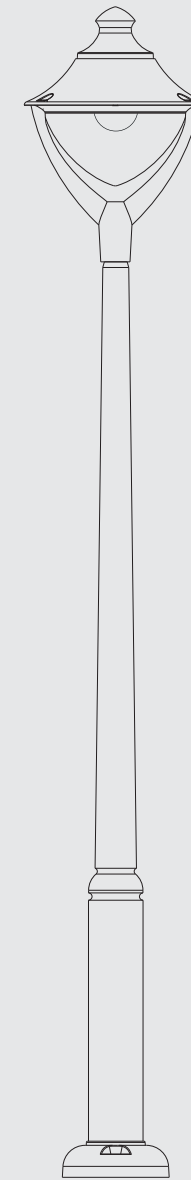

745

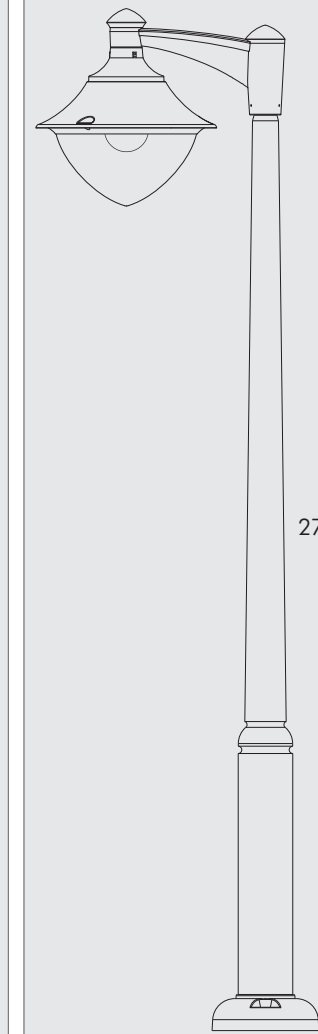

MADE IN ITALY

4 NEWS
28 BOLLARD
46 UP&DOWN
54 FLOODLIGHT
64 IN-GROUND
68 BRICKLIGHT
74 BULKHEAD
92 POST
96 LAMPS



Power surges resistant

- **Wide voltage range (100-240V)** to protect the driver both from voltage droop and voltage overshoot, which are quite frequent in case of outdoor installations.
- **Double 400V capacitors** and multiple resistances to withstand power surges.
- **Silicone paste** to avoid – in case of voltage swings - the vibration of the electronic components of the driver and the consequent risk of components unsoldering.



Heat resistant - Working temperature -30°+80°C

- **Gold wire bonding:** Chips connected by pure gold wires, which are able to withstand at the highest and lowest temperatures and at temperature fluctuations between day and night. The gold wire bonding can grant a lumens maintenance factor > 80%.
- **Silicone paste:** Thermoconductive silicone paste with metal powder inside for helping heat dissipation and avoid overheating problems and for protecting the electronic components in case of high and low temperatures.



Humidity resistant - Weatherproof driver for a longer lifetime

- **Silicone paste:** The driver is fully enclosed in a special silicone paste, which ensures the highest driver protection against moisture and humidity up to 90%, both unavoidable in outdoor installations.



Tested according to :
EN 62560:2012/A1: 2015
IEC/TR 62778:2014
EN 62493:2015



LVD TESTED

EMC TESTED

ERP 6000 h

CB IEC CB SCHEME

RoHS REACH COMPLIANT

LVD Certificate: Fumagalli lamps fulfil the Low Voltage Directive 2014/35/EU, therefore are CE marked and comply with safety requirements like protection against electrical shock, moisture and heat resistance, resistance to flame and ignition.

EMC Certificate: Fumagalli lamps meet the Electromagnetic Compatibility Directive 2014/30/EU and its amendments.

ERP Attestation of conformity: Fumagalli lamps fulfil the European Ecodesign Directive 2009/125/EC and EU 2015/1428 about the energy performance requirements of energy related products. Lamp lumen maintenance factor after 6.000 hrs > 80%

IECEE CB Certificate: Fumagalli lamps meet the International System for Conformity and Certification of Electrotechnical Equipment allowing direct market access in more than 50 countries all over the world.

RoHS REACH compliant: Fumagalli lamps fulfil the RoHS (Restriction of Hazardous Substances) directive 2011/65/EU and its amendments and the REACH regulation (EC) No. 1907/2006, regarding the concentration of Very High Concern Substances (SVHC).

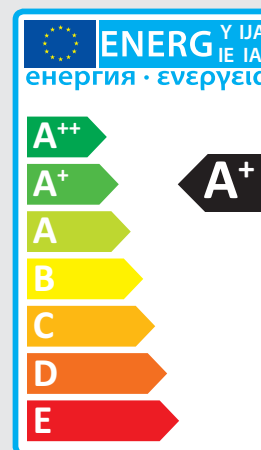

SWITCH

- Long press + 5 sec.: for Mode selection
- Short press: for CCT selection

SOLAR PANEL

- Panel 2W/5V
- Monocrystalline
- Antishock material
- UV rays treated.
- Cover made in PET material granting antishock performances for outdoor use

MATERIAL

- PC material suitable for outdoor use
- UV rays stabilized
- Anti shock

3 WORKING MODE

- ☀️ SUMMER MODE
- ☁️ WINTER MODE
- 📡 SENSOR MODE

REPLACEABLE BATTERY

- Quick and easy battery replacement
- LiFePO4 IFR 26650 3,3Ah-3,2V
- No risk of explosion
- Working temperature -10° to +60°C

PIR SENSOR

- Detection angle 120°
- Fields of detection up to 5m
- Active for 25 sec.

LED

- Power absorption of the led plate 2,5W (at 100% light)
- LED chips connected by pure gold wires able to withstand at the highest and lowest temperatures and granting a lumens maintenance factor > 80%.
- SMD 3528 LED.

CCT SET

CCT SETTABLE

- Press the switch, to select the desired Kelvin temperature (3000K, 4000K, 6500K) and get a customized ambiance.
- 3000K, 4000K and 6500K led chips on 3 separate circuits to grant SDCM < 6.

LENS

- Frosted color lens reducing dazzle.
- Made of UV rays stabilized resin material to avoid yellowing process.
- Very compact and slim design for a better light distribution and for improving the light efficiency.



SOLAR MODULE - CCT SETTABLE



SIZE		
SUMMER MODE ☀️	LUMEN	42
	AUTONOMY	25h
WINTER MODE ☁️	LUMEN	20
	AUTONOMY	46h
SENSORE MODE 📡	LUMEN	280
	ACTIVE TIME	25 sec
	N° Detections	423
SOLAR PANEL 🌞	5V/2W	
	Monocrystalline PET type Antishock material	
CHARGING TIME	6h	
REPLACEABLE BATTERY 🔋	LiFePO4 IFR26650 3,3Ah, 3,2V	
	No Risk of explosion	
	Working temperature -10° to +60°C	
PIR SENSOR 🚶	Longer Lifetime	
	Detection angle 120°	
	Fields of detection up to 5 mt	
LED	3 CIRCUITS	SMD 3528
	COLOR RENDERING INDEX RA	> 80
	SDCM	< 6
	LIFETIME	30.000 h
	KELVIN SETTABLE	3000 K / 4000 K / 6500 K
REF. CODE	H.LED.SOL.CCT	

4 NEWS
28 BOLLARD
46 UP&DOWN
54 FLOODLIGHT
64 IN-GROUND
68 BRICKLIGHT
74 BULKHEAD
92 POST
96 LAMPS

G9 LED

	POWER	1,7 W	
	LUMINOUS FLUX	170 lm	
	SIZE & SOCKET		
	EFFICIENCY	100 lm/W	
	VOLTAGE	100-240 V	
	FREQUENCY	50/60 Hz	
	CURRENT	17 mA	
	COLOR RENDERING INDEX RA	80	
	SDCM	< 6	
	BEAM ANGLE	110°	
	WARM UP TIME	≤ 0,5"	
	SWITCHING CYCLE	> 40.000	
	LIFETIME	15.000 h	
	KELVIN	4000 K	3000 K
REF. CODE	H.LED.G09.4K		H.LED.G09.3K

GU10 LED - CCT SETTABLE

	POWER	3,5 W	6 W	
	LUMINOUS FLUX	350 lm	600 lm	
	SIZE & SOCKET			
	EFFICIENCY	100 lm/W	100 lm/W	
	VOLTAGE	100-240 V		
	FREQUENCY	50/60 Hz		
	CURRENT	70 mA		
	COLOR RENDERING INDEX RA	> 80		
	SDCM	< 6		
	BEAM ANGLE	36°	45°	
	WARM UP TIME	≤ 0,5"		
	SWITCHING CYCLE	> 25.000		
	LIFETIME	25.000 h		
	KELVIN SETTABLE	2700 K / 4000 K		
REF. CODE	H.LED.GU10.CCT			
COMPARISON	3,5W = 50W 		6W = 100W 	

R7s LED 78mm - CCT SETTABLE

	POWER	3,2 W	
	LUMINOUS FLUX	400 lm	
	SIZE & SOCKET		
	EFFICIENCY	133 Lm/W	
	VOLTAGE	100-240 V	
	FREQUENCY	50/60 Hz	
	CURRENT	75 mA	
	POWER FACTOR	> 0,5	
	COLOR RENDERING INDEX RA	> 80	
	SDCM	< 6	
	BEAM ANGLE	360°	
	WARM UP TIME	≤ 0,5"	
	SWITCHING CYCLE	45.000	
	LIFETIME	25.000 h	
KELVIN	2700 K / 4000 K / 6500 K		
REF. CODE	H7.LED.R7S.CCT		

R7s LED 118mm - CCT SETTABLE

	POWER	7,5 W	
	LUMINOUS FLUX	850 lm	
	SIZE & SOCKET		
	EFFICIENCY	113 Lm/W	
	VOLTAGE	100-240 V	
	FREQUENCY	50/60 Hz	
	CURRENT	168 mA	
	POWER FACTOR	> 0,5	
	COLOR RENDERING INDEX RA	> 80	
	SDCM	< 6	
	BEAM ANGLE	360°	
	WARM UP TIME	≤ 0,5"	
	SWITCHING CYCLE	45.000	
	LIFETIME	25.000 h	
KELVIN	2700 K / 4000 K / 6500 K		
REF. CODE	H8.LED.R7S.CCT		

R7s LED 189mm - CCT SETTABLE

	POWER	10,5 W	
	LUMINOUS FLUX	1100 lm	
	SIZE & SOCKET		
	EFFICIENCY	104 Lm/W	
	VOLTAGE	100-240 V	
	FREQUENCY	50/60 Hz	
	CURRENT	170 mA	
	POWER FACTOR	> 0,5	
	COLOR RENDERING INDEX RA	> 80	
	SDCM	< 6	
	BEAM ANGLE	360°	
	WARM UP TIME	≤ 0,5"	
	SWITCHING CYCLE	45.000	
	LIFETIME	25.000 h	
KELVIN	2700 K / 4000 K / 6500 K		
REF. CODE	H9.LED.R7S.CCT		

4 NEWS
28 BOLLARD
46 UP&DOWN
54 FLOODLIGHT
64 IN-GROUND
68 BRICKLIGHT
74 BULKHEAD
92 POST
96 LAMPS

E27 LED FILAMENT A60

POWER	6 W	8 W
LUMINOUS FLUX	800 lm	1000 lm
SIZE & SOCKET		
EFFICIENCY	133 Lm/W	125 Lm/W
VOLTAGE	100-240 V	100-240 V
FREQUENCY	50/60 Hz	50/60 Hz
CURRENT	60 mA	76 mA
POWER FACTOR	> 0,7	> 0,7
COLOR RENDERING INDEX RA	> 80	> 80
SDCM	< 6	< 6
BEAM ANGLE	360°	360°
WARM UP TIME	≤ 0,5"	≤ 0,5"
SWITCHING CYCLE	> 100.000	> 100.000
LIFETIME	25.000 h	
KELVIN	4000K	2700 K
REF. CODE	H.LED.FIL.4K	H.LED.FIL.3K
COMPARISON	6W = 800 Lm = 60W incandescent SAVE 90%	8W = 1000 Lm = 75W incandescent SAVE 89%

INDOOR & OUTDOOR USE

-30 +80 °C 90% HUMIDITY

VOLTAGE SURGE RESISTANT

LVD EMC ERP 6000h

IECEE CB CERTIFICATE: SG PSB-LE-01711

E27 LED FILAMENT A70

POWER	12 W
LUMINOUS FLUX	1500 lm
SIZE & SOCKET	
EFFICIENCY	125 Lm/W
VOLTAGE	100-240 V
FREQUENCY	50/60 Hz
CURRENT	100 mA
POWER FACTOR	> 0,7
COLOR RENDERING INDEX RA	> 80
SDCM	< 6
BEAM ANGLE	360°
WARM UP TIME	≤ 0,5"
SWITCHING CYCLE	> 100.000
LIFETIME	25.000 h
KELVIN	4000K
REF. CODE	H3.LED.FIL.4K
COMPARISON	12W = 1500 Lm = 100W incandescent SAVE 88%

INDOOR & OUTDOOR USE

-30 +80 °C 90% HUMIDITY

VOLTAGE SURGE RESISTANT

LVD EMC ERP 6000h

IECEE CB CERTIFICATE: SG PSB-LE-01711

E27 HIGH POWER LED

POWER	15 W	30 W
LUMINOUS FLUX	1800 lm	3500 lm
SIZE & SOCKET		
EFFICIENCY	120 Lm/W	116 Lm/W
VOLTAGE	100-240 V	100-240 V
FREQUENCY	50/60 Hz	50/60 Hz
CURRENT	130 mA	135 mA
POWER FACTOR	> 0,5	> 0,9
COLOR RENDERING INDEX RA	> 80	> 80
BEAM ANGLE	200°	200°
WARM UP TIME	< 0,5"	< 1"
SWITCHING CYCLE	30.000	30.000
LIFETIME	25.000 h	
KELVIN	4000 K	3000 K
REF. CODE	H3.LED.HIP.4K	H3.LED.HIP.3K
COMPARISON	15W = 1800 Lm = 100W incandescent SAVE 85%	30W = 3500 Lm = 50W HQL-SON SAVE 40%

INDOOR & OUTDOOR USE

-30 +80 °C 90% HUMIDITY

VOLTAGE SURGE RESISTANT

LVD EMC ERP 6000h

IECEE CB CERTIFICATE: SG PSB-LE-01712
SG PSB-LE-01708

E27 HIGH POWER LED

POWER	50 W	60 W
LUMINOUS FLUX	5300 lm	7000 lm
SIZE & SOCKET		
EFFICIENCY	106 Lm/W	116 Lm/W
VOLTAGE	100-240 V	100-240 V
FREQUENCY	50/60 Hz	50/60 Hz
CURRENT	210 mA	290 mA
POWER FACTOR	> 0,9	> 0,9
COLOR RENDERING INDEX RA	> 80	> 80
SDCM	< 6	< 6
BEAM ANGLE	200°	200°
WARM UP TIME	< 1"	< 0,5"
SWITCHING CYCLE	30.000	30.000
LIFETIME	25.000 h	
KELVIN	4000 K	3000 K
REF. CODE	H.LED.HIP.4K	H.LED.HIP.3K
COMPARISON	50W = 5300 Lm = 70W HQL-SON SAVE 30%	60W = 7000 Lm = 100W HQL-SON SAVE 40%

INDOOR & OUTDOOR USE

-30 +80 °C 90% HUMIDITY

VOLTAGE SURGE RESISTANT

LVD EMC ERP 6000h

IECEE CB CERTIFICATE: SG PSB-LE-01707
SG PSB-LE-01705

GX53 LED Ø75 - CCT SETTABLE

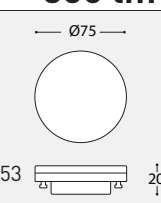
 <p>NEW CCT SETTABLE 3000 K 4000 K 6500 K SDCM <6</p> <p>INDOOR & OUTDOOR USE -30 +80 °C 90% HUMIDITY VOLTAGE SURGE RESISTANT</p> <p>TÜV CB LVD EMC ERP 6000h IECEE IECEE CB CERTIFICATE: SG PSB-LE-01706</p>	POWER	3 W	
	LUMINOUS FLUX	350 lm	
	SIZE & SOCKET	<p>NEW VERSION CCT SETTABLE LAMP</p> 	
	EFFICIENCY	116 Lm/W	
	VOLTAGE	100-240 V	
	FREQUENCY	50/60 Hz	
	CURRENT	30 mA	
	COLOR RENDERING INDEX RA	> 80	
	SDCM	< 6	
	BEAM ANGLE	120°	
WARM UP TIME	0 s		
SWITCHING CYCLE	> 30.000		
LIFETIME	25.000 h		
KELVIN SETTABLE	NEW 3000 K / 4000 K / 6500 K		
REF. CODE	H.LED.G53.CCT		
COMPARISON	<p>3W = 40W 350 Lm incandescent SAVE 93%</p>		

GX53 LED Ø180mm

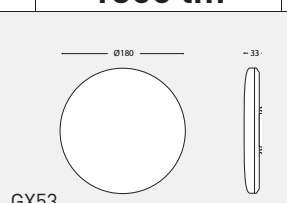
 <p>SILICONE PROTECTION DRIVER (11W-18W)</p> <p>INDOOR & OUTDOOR USE -30 +80 °C 90% HUMIDITY VOLTAGE SURGE RESISTANT</p> <p>TÜV CB LVD EMC ERP 6000h IECEE IECEE CB CERTIFICATE: SG PSB-LE-01704 SG PSB-LE-01713</p>	POWER	7 W	11 W	18 W		
	LUMINOUS FLUX	600 lm	1300 lm	2000 lm		
	SIZE & SOCKET					
	EFFICIENCY	86 Lm/W	118 Lm/W	111 Lm/W		
	VOLTAGE	100-240 V	100-240 V	100-240 V		
	FREQUENCY	50/60 Hz	50/60 Hz	50/60 Hz		
	CURRENT	60 mA	150 mA	200 mA		
	POWER FACTOR	0,5	0,9	0,9		
	CRI (RA)	> 80	> 80	> 80		
	BEAM ANGLE	90°	90°	90°		
WARM UP TIME	≤ 0,5"	≤ 0,5"	≤ 0,5"			
SWITCHING CYCLE	30.000	> 25.000	> 25.000			
LIFETIME	25.000 h	25.000 h	25.000 h			
KELVIN	4000 K	3000 K	4000 K	3000 K	4000 K	3000 K
REF. CODE	H6.LED.G53.4K	H6.LED.G53.3K	H4.LED.G53	H4.LED.G53.3K	H5.LED.G53.4K	H5.LED.G53.3K
COMPARISON	<p>7W = 60W 800 Lm incandescent SAVE 88%</p>		<p>11W = 100W 1300 Lm incandescent SAVE 89%</p>		<p>18W = 150W 2000 Lm incandescent SAVE 88%</p>	

GX53 LED Ø100mm - CCT SETTABLE

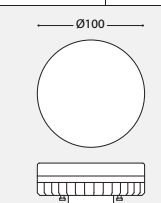
 <p>NEW CCT SETTABLE 3000 K 4000 K 6500 K SDCM <6</p> <p>SILICONE PROTECTION DRIVER INDOOR & OUTDOOR USE -30 +80 °C 90% HUMIDITY VOLTAGE SURGE RESISTANT</p> <p>TÜV CB LVD EMC ERP 6000h IECEE IECEE CB CERTIFICATE: SG PSB-LE-01709</p>	POWER	7 W	10 W
	LUMINOUS FLUX	800 lm	1200 lm
	SIZE & SOCKET	<p>NEW VERSION CCT SETTABLE LAMP</p> 	
	EFFICIENCY	114 Lm/W	120 Lm/W
	VOLTAGE	100-240 V	100-240 V
	FREQUENCY	50/60 Hz	50/60 Hz
	CURRENT	34 mA	48 mA
	POWER FACTOR	0,8	0,8
	COLOR RENDERING INDEX RA	> 80	> 80
	SDCM	< 6	< 6
BEAM ANGLE	120°	120°	
WARM UP TIME	0 s	0 s	
SWITCHING CYCLE	> 30.000	> 30.000	
LIFETIME	25.000 h	25.000 h	
KELVIN SETTABLE	NEW 3000 K / 4000 K / 6500 K		
REF. CODE	H2.LED.G53.CCT	H3.LED.G53.CCT	
COMPARISON	<p>7W = 75W 800 Lm incandescent SAVE 90%</p>		<p>10W = 100W 1200 Lm incandescent SAVE 90%</p>

LOOKING FOR A MODERN DESIGN PRODUCT?

See our **Top selection 2020** dedicated to our **classic range!**



NEW FUMAGALLI POLES FACTORY!



TO SEE OUR COMPLETE COLLECTION

Ask for our
General Catalogue 2021
or visit our website at
www.fumagalli.it



RESIN MATERIAL ADVANTAGES



NO MAINTENANCE

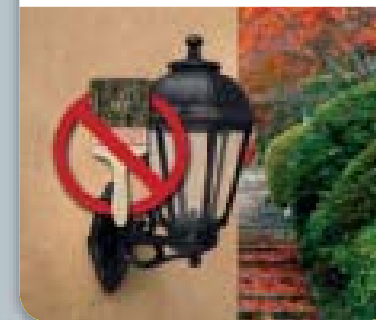

ANTI-CORROSION



DOUBLE INSULATION



NOT AFFECTED BY
CHEMICAL FERTILIZERS



UV-RAY STABILIZED

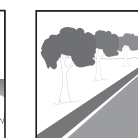
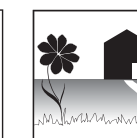
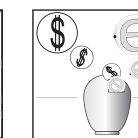
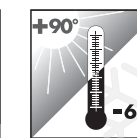
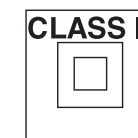

HOW TO READ THE CODE

DIFFUSER	STRUCTURE	SYSTEM	COLOUR OF THE STRUCTURE	COLOUR OF THE DIFFUSER	ELECTRIFICATION	VARIANT
IDENTIFIES THE DIFFUSER	IDENTIFIES THE STRUCTURE ON WHICH THE DIFFUSER IS MOUNTED (POLE, BRACKET, BASE, SPIKE)	IDENTIFIES THE MULTILIGHT SYSTEM IF PRESENT	IDENTIFIES THE COLOUR OF THE STRUCTURE	IDENTIFIES THE COLOUR OF THE DIFFUSER	IDENTIFIES THE TYPE OF ELECTRIFICATION AND THE EVENTUAL PRESENCE OF BULBS	IDENTIFIES THE PRESENCE OF COMPONENTS SUCH AS AN EVENTUAL LOUVRE OR BACKLIT BASE ON THE BULKHEAD RANGE
1R3	613	X20	A BLACK W WHITE L GREY	X CLEAR/FROSTED Y OPAL Z SMOKED N GREEN R ORANGE U BLUE	B1L	OR1

MADE IN ITALY



VIASVET.RU

